

**20MM OUTDOOR
PORCELAIN TILES**
COLLECTION - 2023-'24

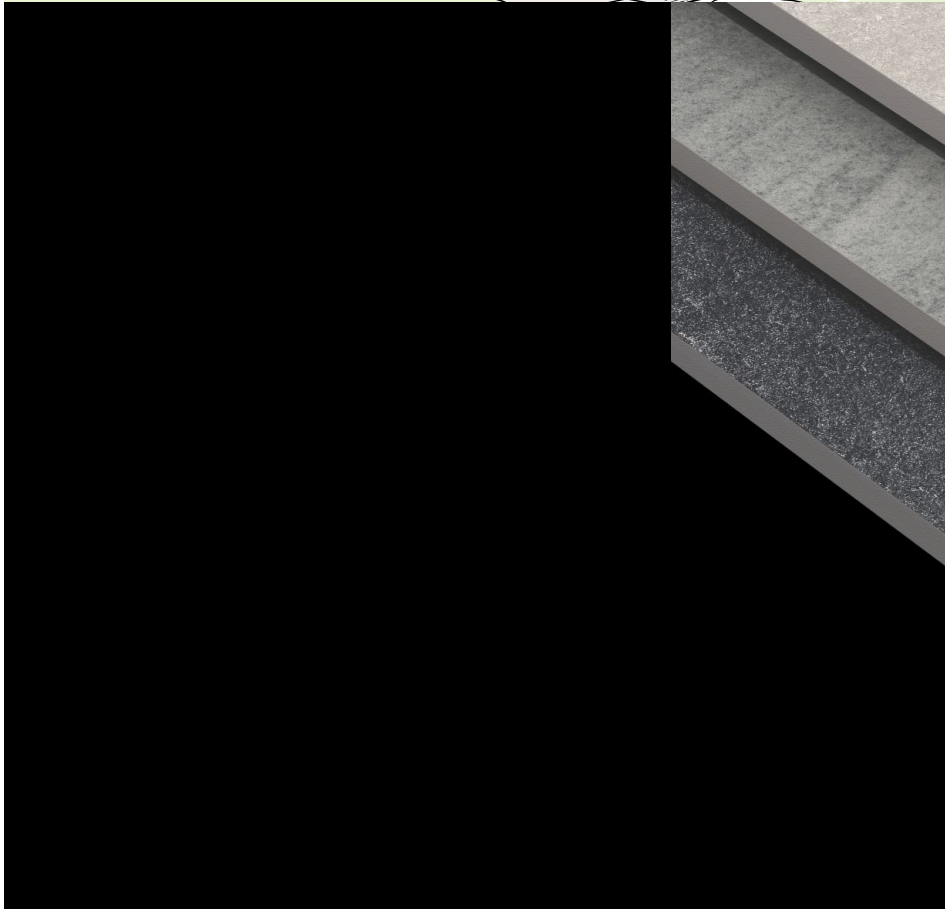
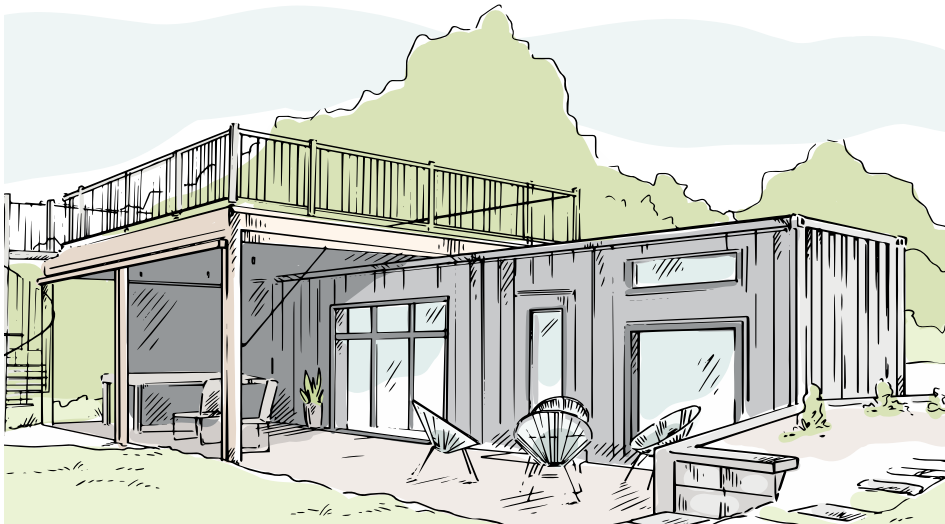

SIMSTONE

**20MM OUTDOOR
PORCELAIN TILES**
COLLECTION - 2023-'24

A CONFLUENCE OF
NATURE & TECHNOLOGY



SIMSTONE

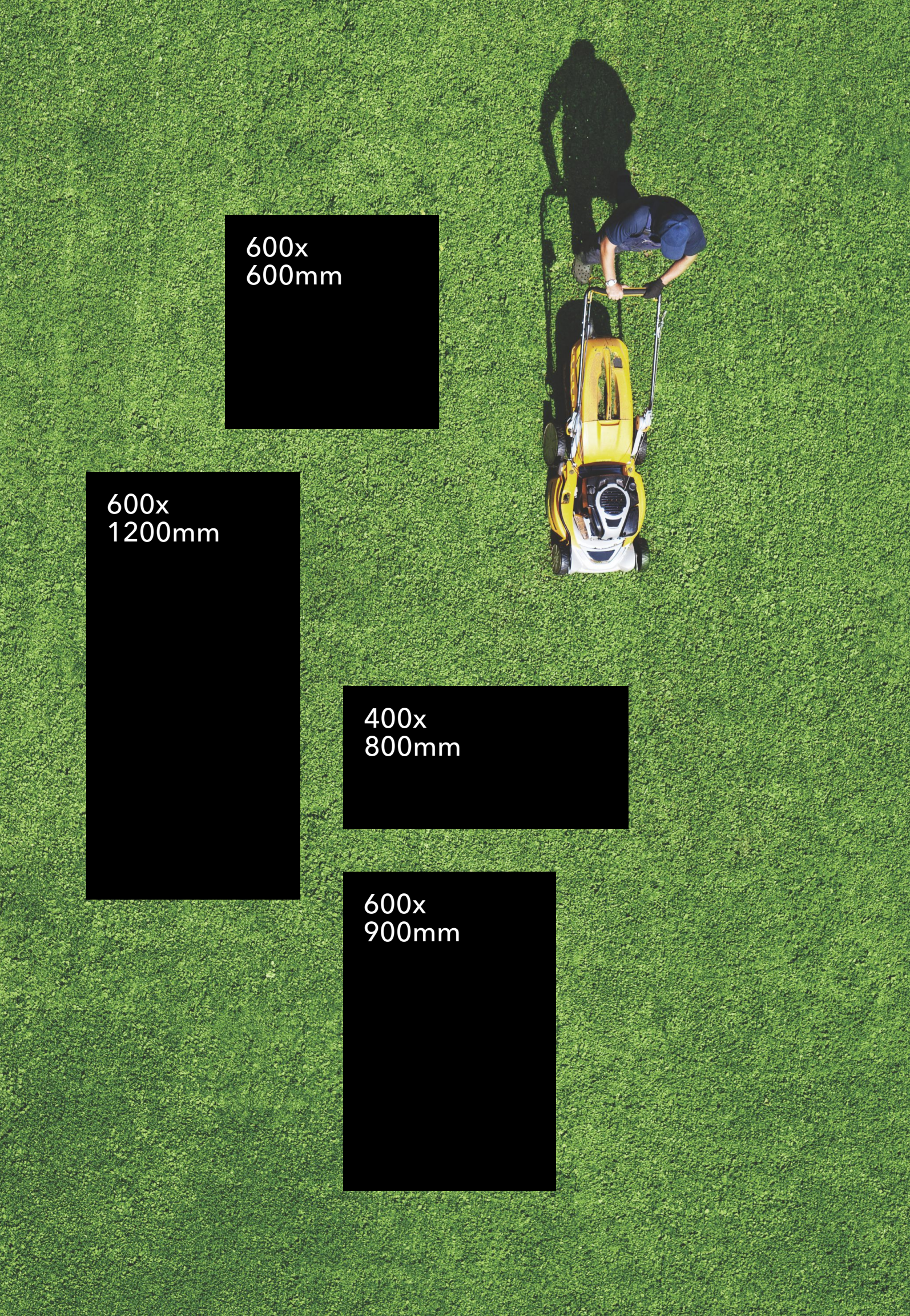

600x
600mm

600x
1200mm

400x
800mm

600x
900mm

20MM OUTDOOR PORCELAIN TILES

DISCOVER THE COLLECTION OF RESILIENT SURFACES CRAFTED WITH THE CONVERGENCE OF NATURE AND TECHNOLOGY FOR DEMANDING OUTDOORS AND AREAS THAT ARE AN EXTENSION OF YOUR HOMES AND SPACES.

The outdoors of your homes and spaces are the first impression that you make on your guests and they are also the places that endure the most. Keeping in mind the aesthetics, functionality, and resilience your outdoor spaces require, Simstone is here with an exclusive collection of outdoor tiles which is packed with superior aesthetics, endurance, and functionality that will not let you compromise on the outdoor tiling of

your spaces and transform those areas in practical and presentable spaces. The exclusive collection offers outdoor colorbody tiles in robust 20mm thickness and four versatile sizes 600x1200mm, 600x900mm, 600x600mm, and 400x800mm that cater to every tiling need. Packed with a plethora of features the collection blends strength, style, and resilience in your spaces.

TILE LAYING POSSIBILITIES

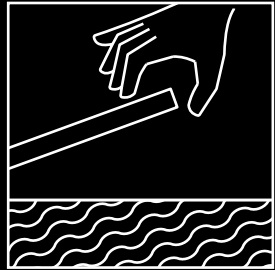

LAYING ON SCREED WITH ADHESIVES



Laying on screed with adhesives
Lay the 20mm outdoor tiles on a bed of screed with adhesives for heavy traffic areas like parking, courtyards, and others like swimming pool borders, outdoor flooring, sit-out areas, and more.

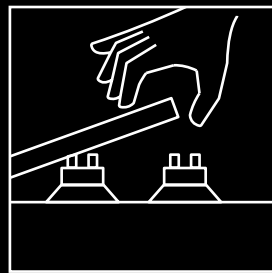

LAYING ON A RAISED FLOOR

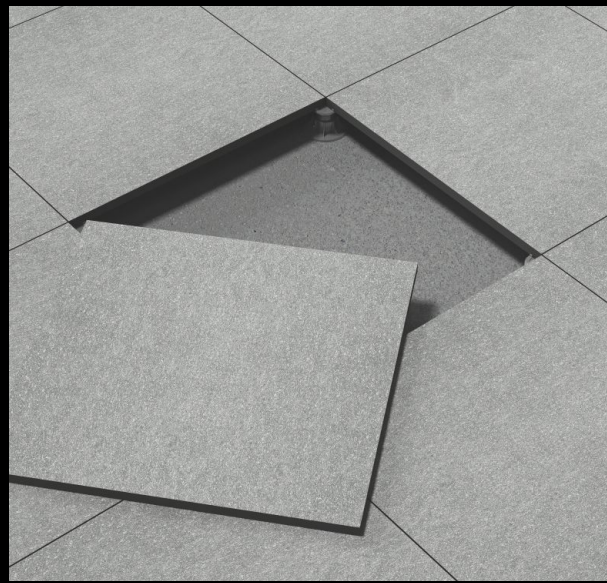

Tile uneven areas, terrains, and more and transform them enduring by laying 20mm outdoor tiles on raised floor pedestals, frames, and more. Create room for a heating system, insulation, additional raised area, and more with the extensive laying possibilities of this collection.

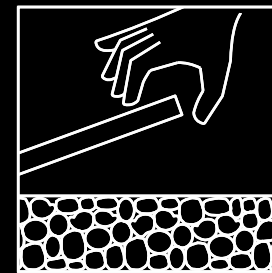

LAYING ON GRAVEL

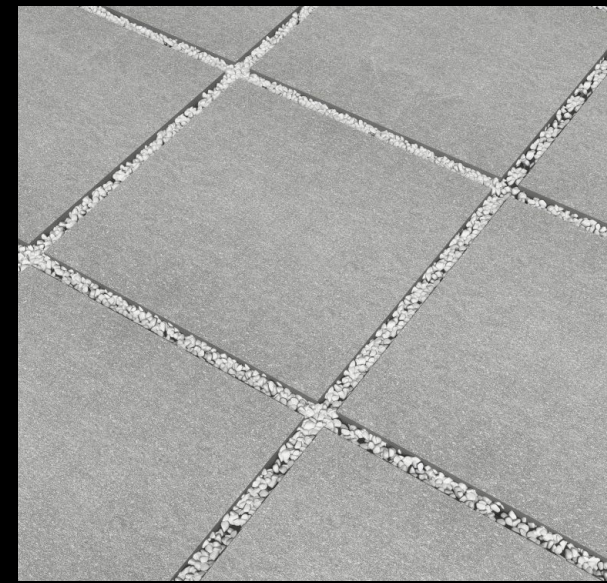

The robust and resilient collection is ideal for laying directly on gravel in your outdoors with or without adhesive. Create a stepping stone path, patio, and more by just laying the thick tiles on the gravel in your outdoors.

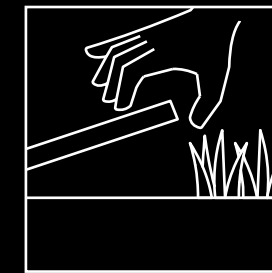

DRY LAYING ON THE GRASS



Shape elegant pathways, outdoor leisure areas, and more by dry laying the 20mm outdoor tiles on the grass in your gardens and other areas surrounding the building. The laying possibility opens door to fuss-free outdoor tiling.

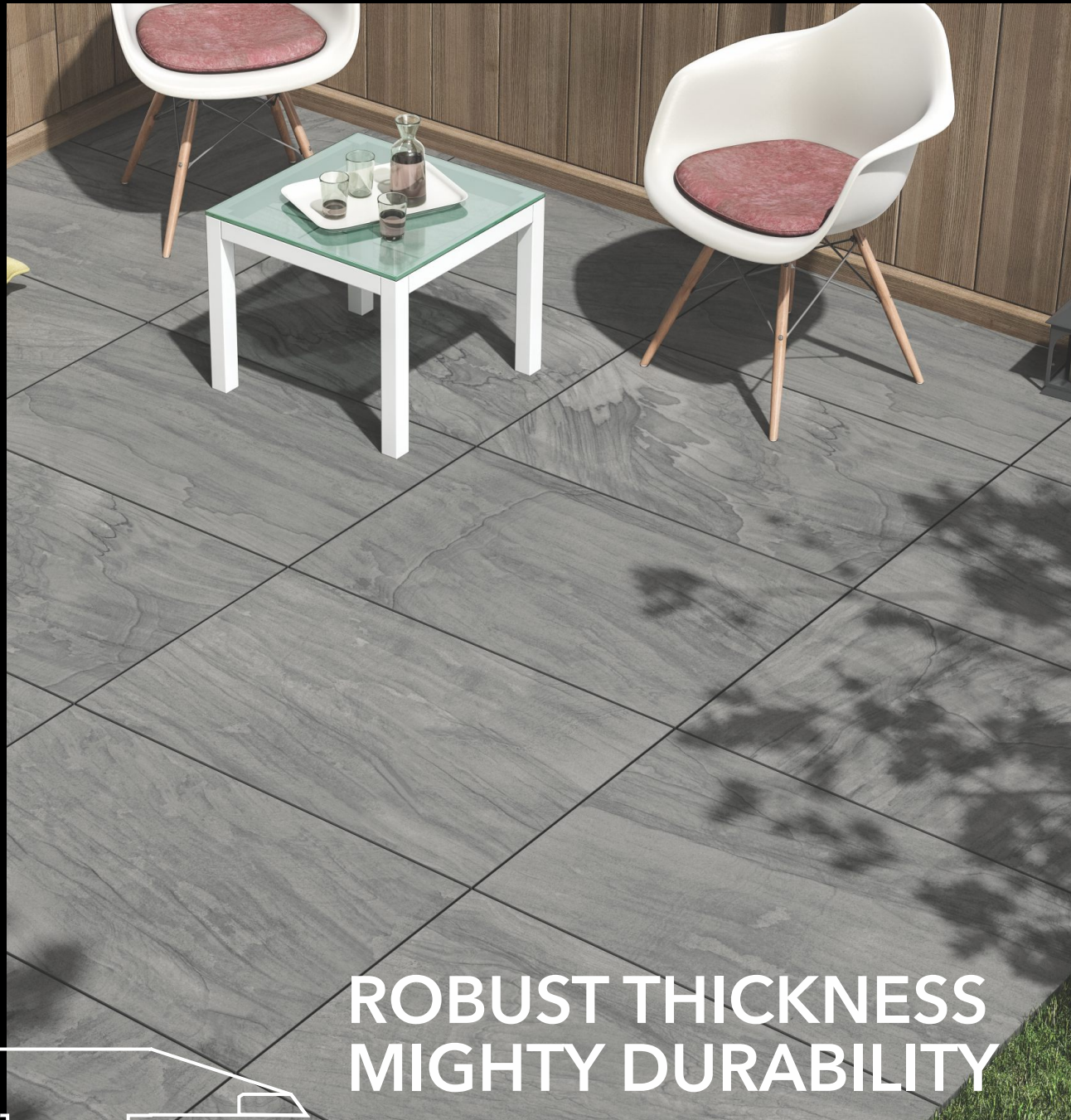

**ROBUST THICKNESS
MIGHTY DURABILITY**

20MM

The substantial thickness of 20mm of the collection lends the surfaces exceptional durability and resilience. The thickness offers surfaces durability to endure heavy traffic, weight, and rugged use and makes the surfaces practically ideal for all kinds of usages. The thickness paired with R11 anti-skid surfaces makes the surfaces of the collection extremely safe for use outdoors.

BENIFITS OF 20MM OUTDOOR TILES

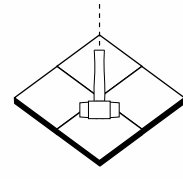
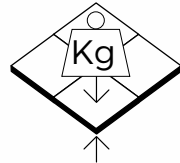
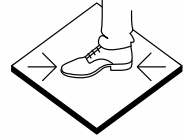
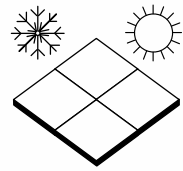
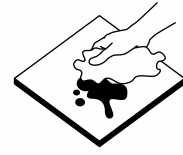
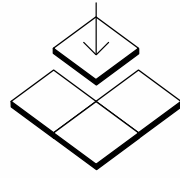
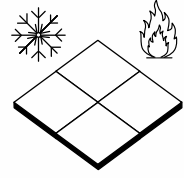
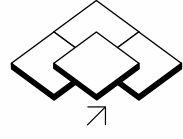
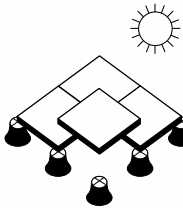
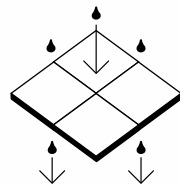
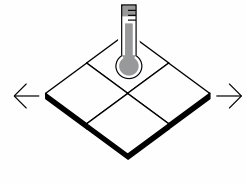
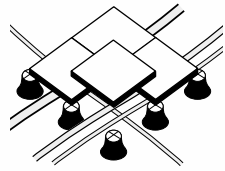
 <p>Stress-resistant</p>	 <p>High tensile strength</p>	 <p>Antislip (R11)</p>	 <p>Weather resistant</p>
 <p>Easy to clean due to the lack of adhesives and filler</p>	 <p>Easy to install even without adhesives or filler</p>	 <p>Frost and fire-resistant</p>	 <p>Removable and reusable</p>
 <p>Ideal for paving outdoor installations, including raised paving.</p>	 <p>Good drainage, facilitates the flow of water and rainfall, eliminating harmful stagnation</p>	 <p>Highly resistant to changes in temperature</p>	 <p>Easily inspected and functional, allows installation and maintenance of cabling and pipework.</p>

The robustly crafted collection comes with a plethora of features and benefits and aids in an effortless and risk-free lifestyle with attributes like r11 anti-slip surfaces, resistance to heat, frost, fire, weather, stains, and more, and also very easy to maintain. On top of features, the surfaces are easy to install, removable, and reusable.

APPLICATIONS AND SOLUTIONS

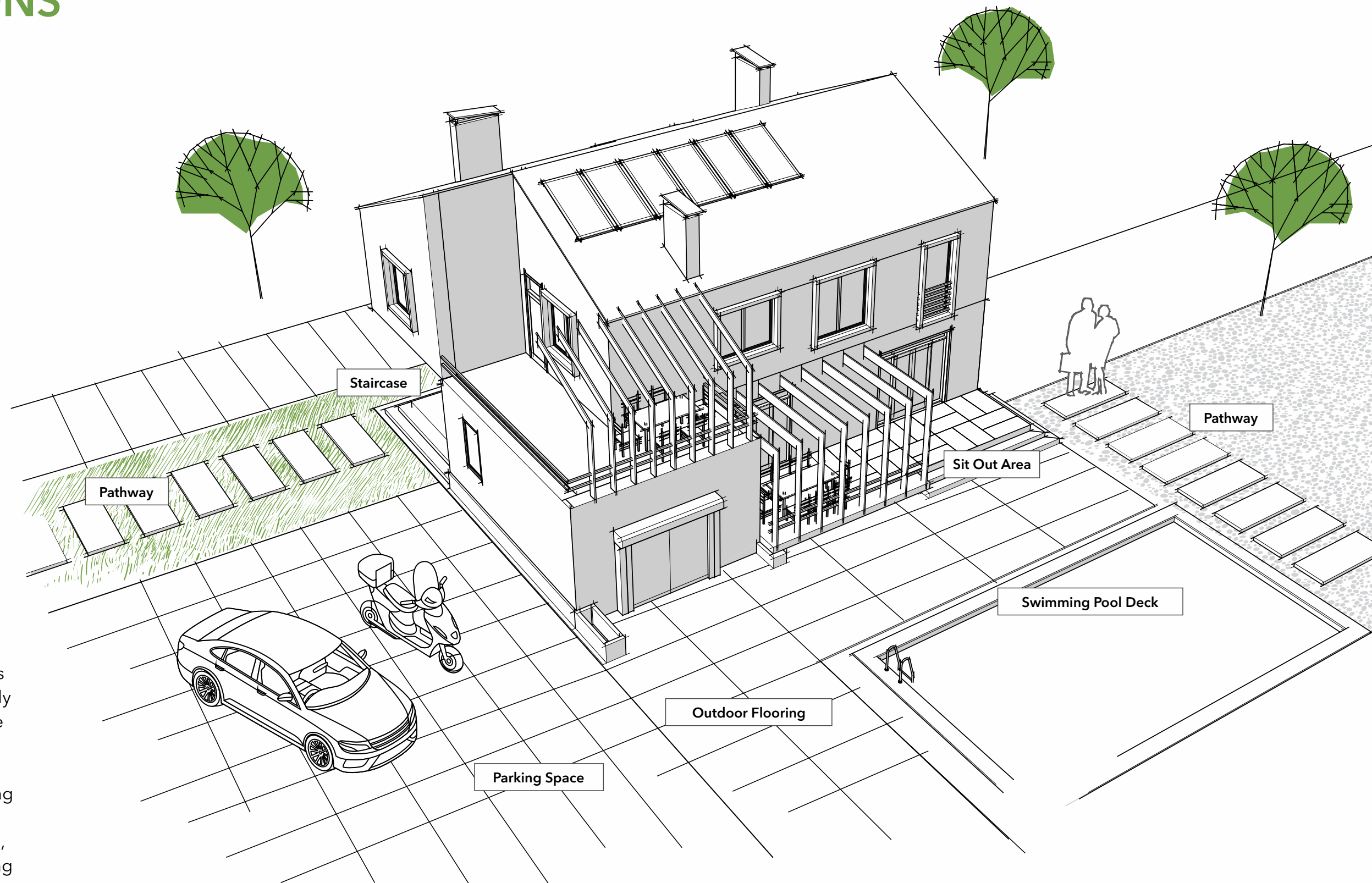

DESIGN YOUR OUTDOOR SPACES

The extensive application possibilities of the collection allow you to elegantly and practically tile your outdoors. The versatile and extremely durable collection due to its functional characteristics is ideal for tiling parking spaces, outdoor floors, staircases, pathways, benches, outdoor furniture, pavements, patios, gardens, swimming pool decks, and more.

Enjoy your outdoor worry-free with the superior blend of strength and aesthetics of the 20mm outdoor collection of Simstone crafted to help you appreciate your outdoors.



APPLICATION AREAS

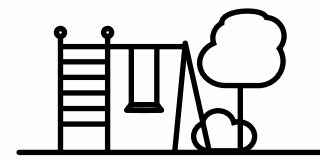

Public Parks & Gardens

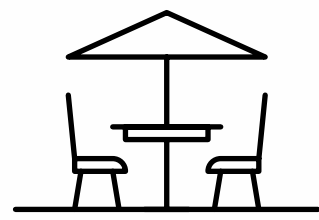

Terraces & Balconies

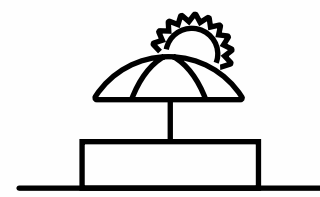

Beach Resorts

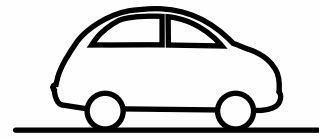

Parking Lots

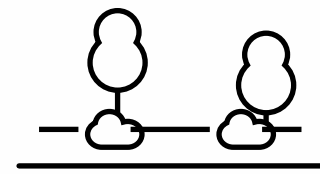

Driveways & Pathways

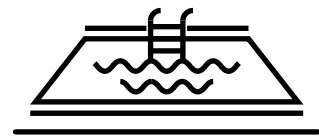

Swimming Pool Decks

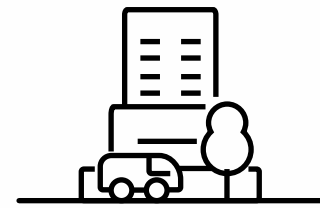

Street Furniture

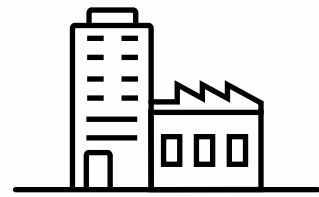

High-Traffic Industrial Areas

LAYING PATTERNS

ACHIEVE VISUALLY APPEALING OUTDOORS WITH MULTIPLE LAYING PATTERN POSSIBILITIES.

Explore extensive tile-laying pattern possibilities with the multiple sizes of the 20mm outdoor tile collection. The four different sizes of the collection allow you to mix and match tile sizes for a unique lay in your spaces. Mix two or

more sizes and spruce up your tiling game outdoors with the elegant tile-laying combination possibility with the versatile tile sizes and robust thickness of the collection ideal for reusing and relocating tiles.

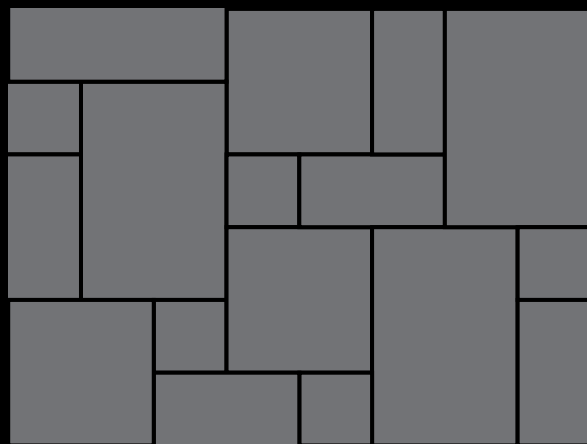

Tiles Combination
600x900mm, 600x600mm, 300x600mm, 300x300mm

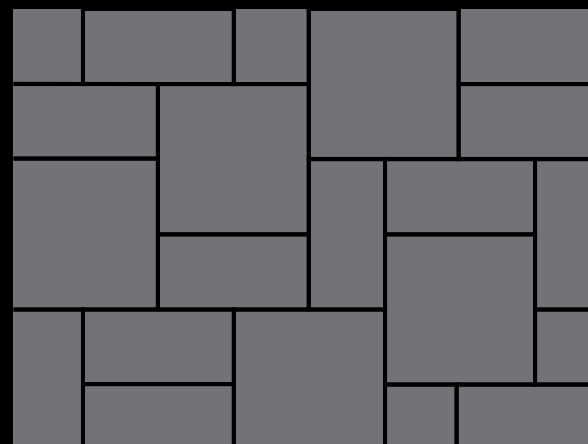

Tiles Combination
600x600mm, 300x600mm

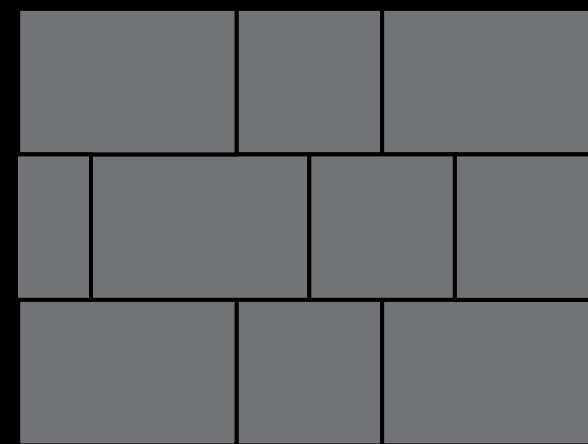

Tiles Combination
600x900mm, 600x600mm

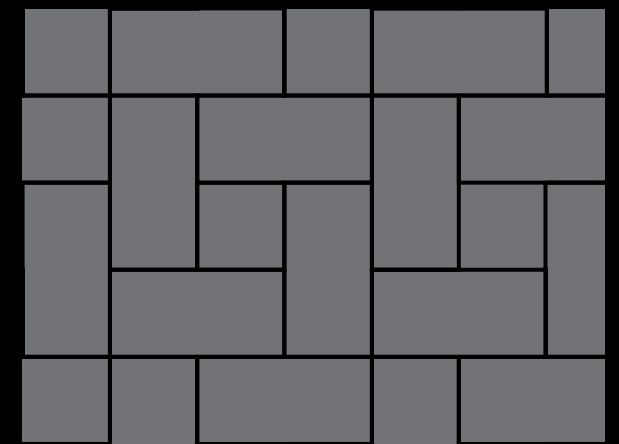

Tiles Combination
600x1200mm, 600x600mm

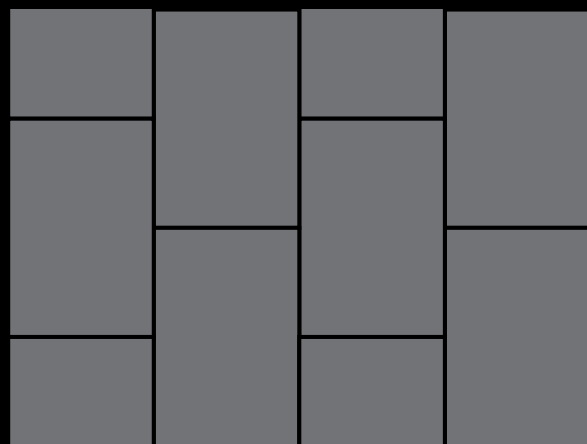

Tiles Combination
600x900mm

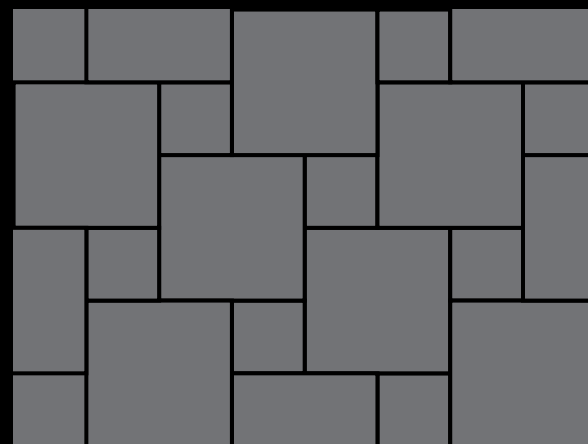

Tiles Combination
600x600mm, 300x300mm

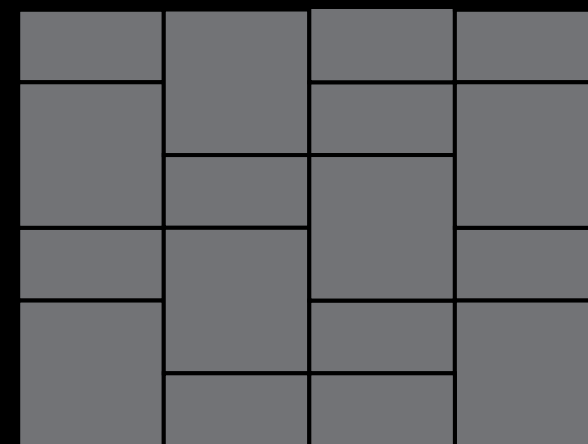

Tiles Combination
600x600mm, 300x600mm

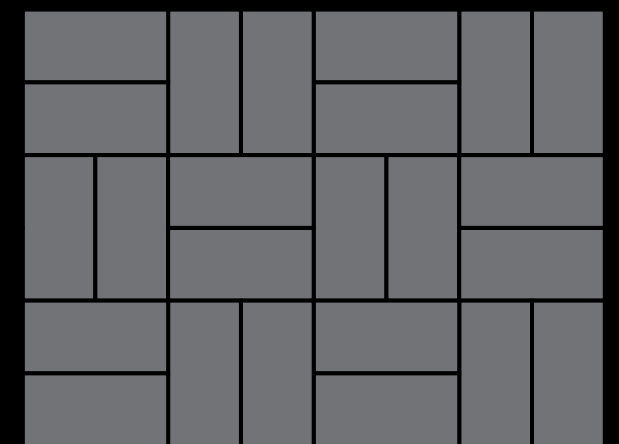

Tiles Combination
300x600mm



Floor - Lava Slate - 600x600mm

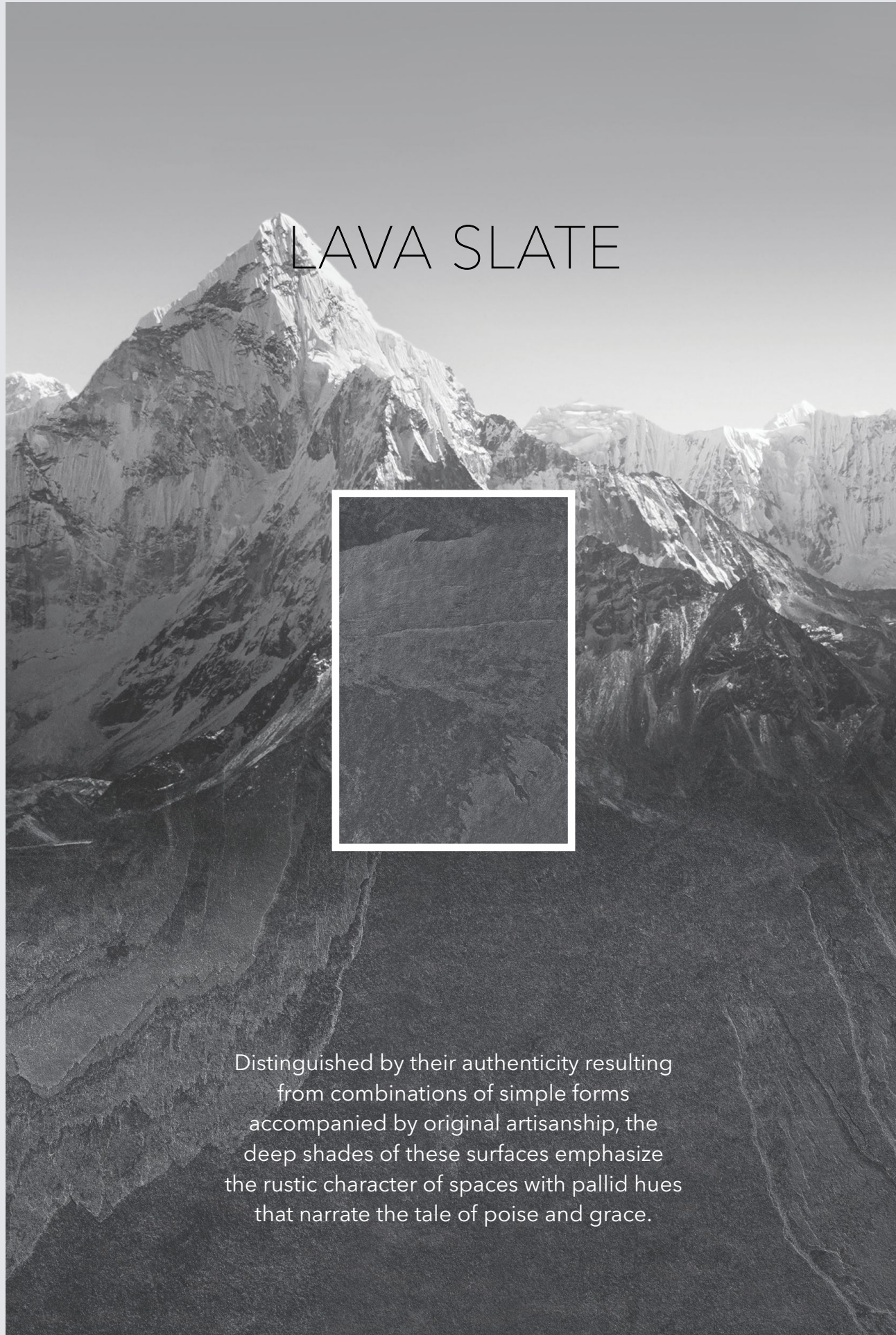

Distinguished by their authenticity resulting from combinations of simple forms accompanied by original artisanship, the deep shades of these surfaces emphasize the rustic character of spaces with pallid hues that narrate the tale of poise and grace.

LAVA SLATE



Size **600x900mm** Surface **Matt**
Body Type **Black** Random **4**

Available Sizes

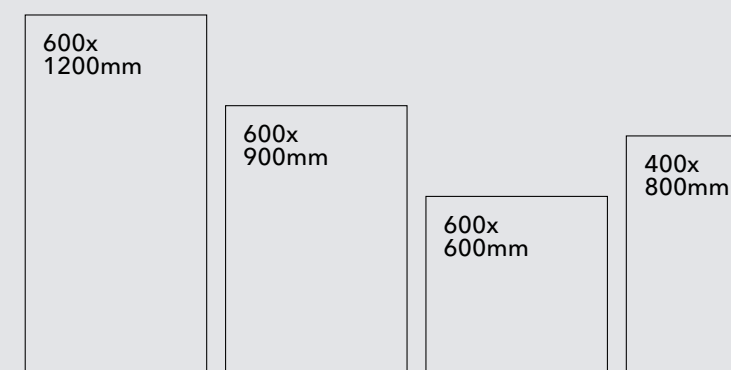



Floor - Creek Wave Nero - 600x900mm

CREEK WAVE NERO



Taking cues from asymmetrical forms of nature, the tiles capture the swaying patterns, the impressions of the creeks, the waves, and the veining that will imbue any space with a sense of harmony, vitality, and connection with nature.

CREEK WAVE NERO

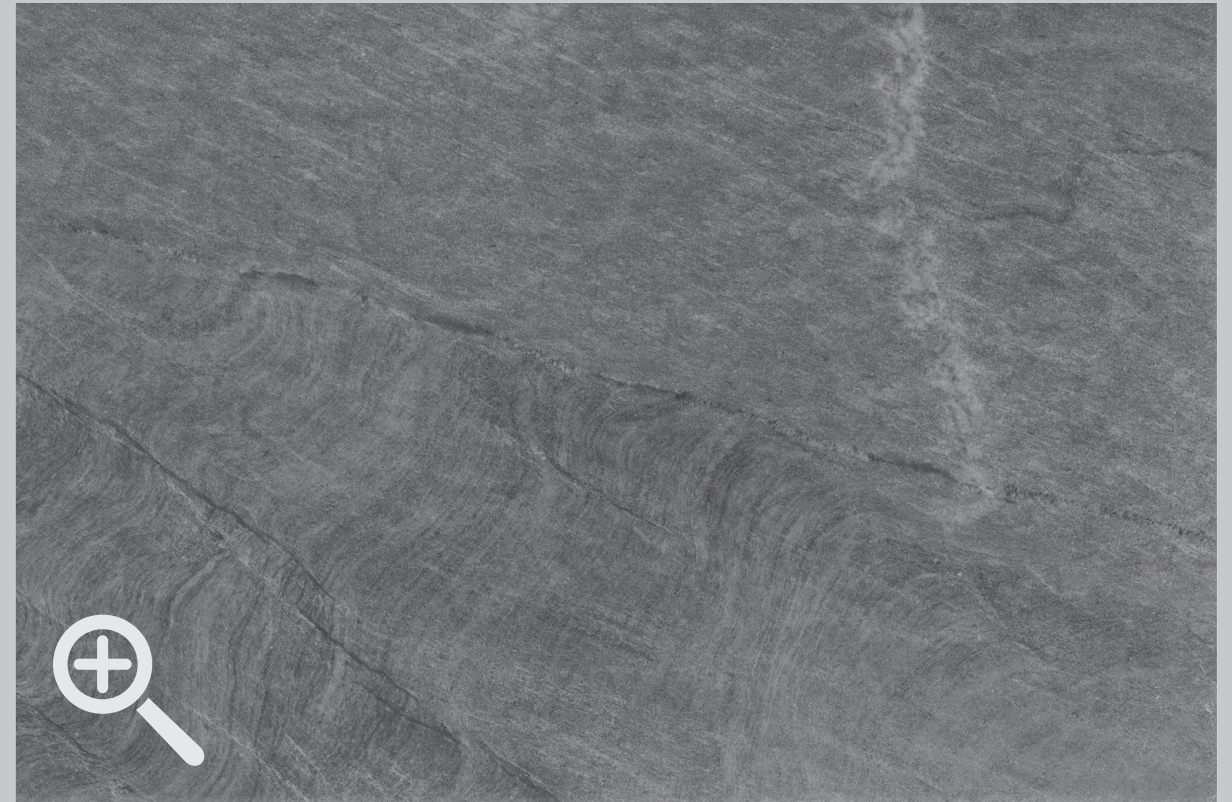

Size **600x900mm** Surface **Matt**
Body Type **Black** Random **7**

Available Sizes

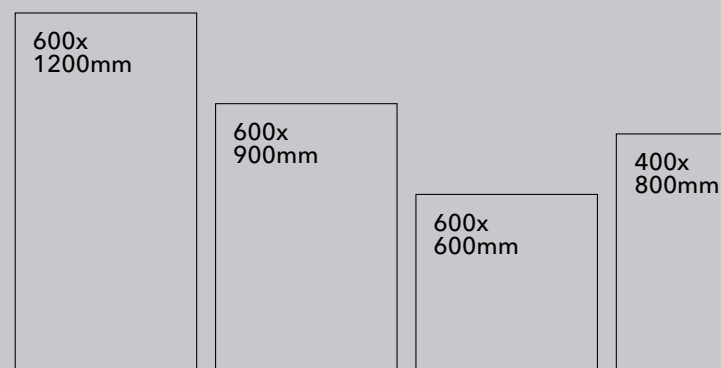



Floor - Newton Grey - 600x900mm

NEWTON GREY

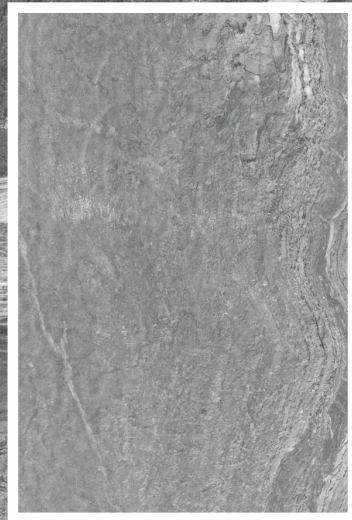

The hues of grey symbolize tranquillity, wisdom, and peace. The aesthetic appearance of these elegant surfaces up your style quotient with the simplicity that brings out a radical and appealing character into your ambiance.

NEWTON GREY

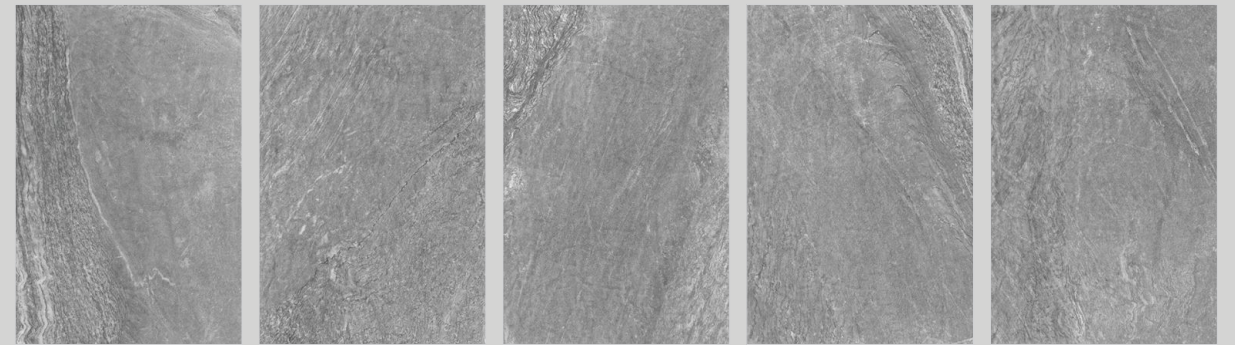

Size **600x900mm** Surface **Matt**
Body Type **Grey** Random **7**

Available Sizes

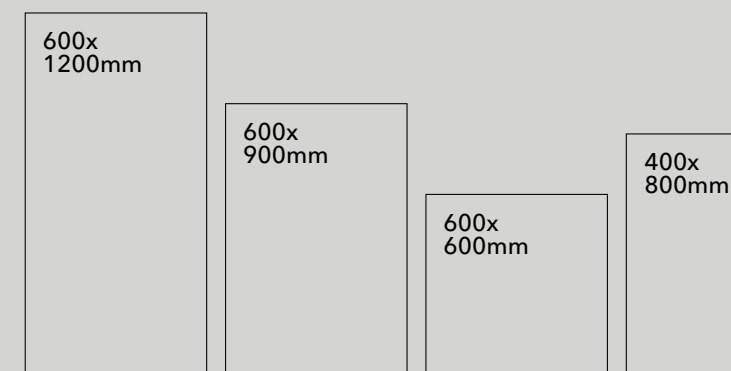



Floor - Teak Stone Concrete - 600x900mm

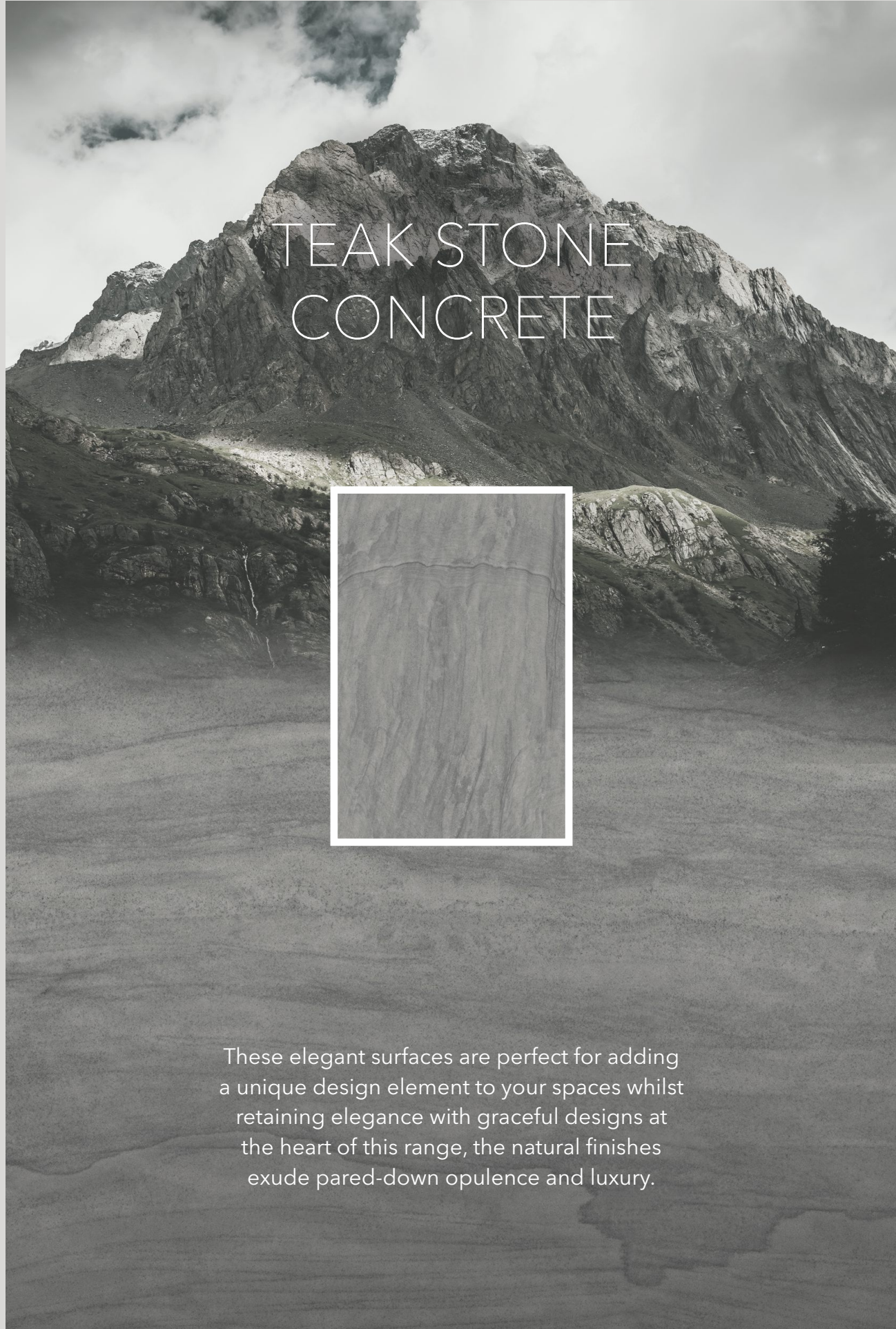

These elegant surfaces are perfect for adding a unique design element to your spaces whilst retaining elegance with graceful designs at the heart of this range, the natural finishes exude pared-down opulence and luxury.

TEAK STONE CONCRETE

Available Colors

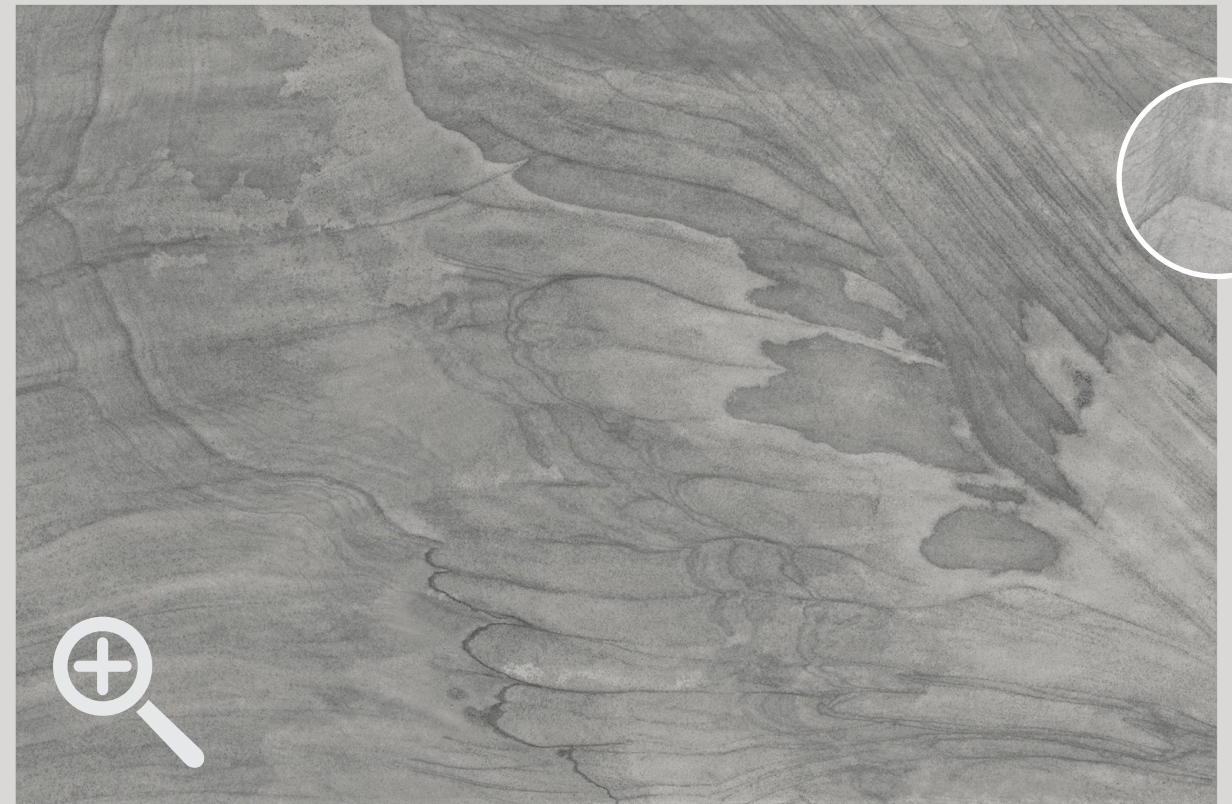

Size **600x900mm** Surface **Matt**
Body Type **Grey** Random **9**

Available Sizes

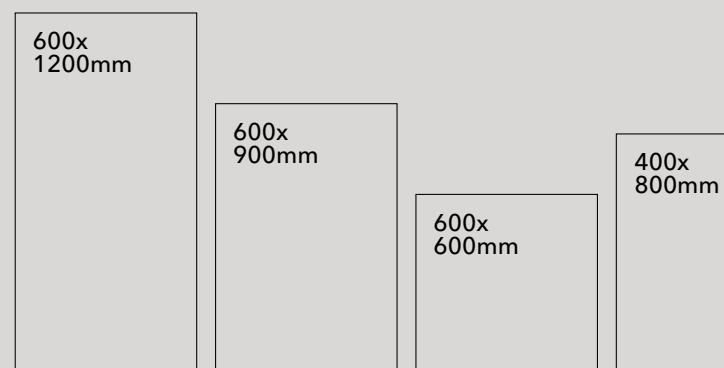

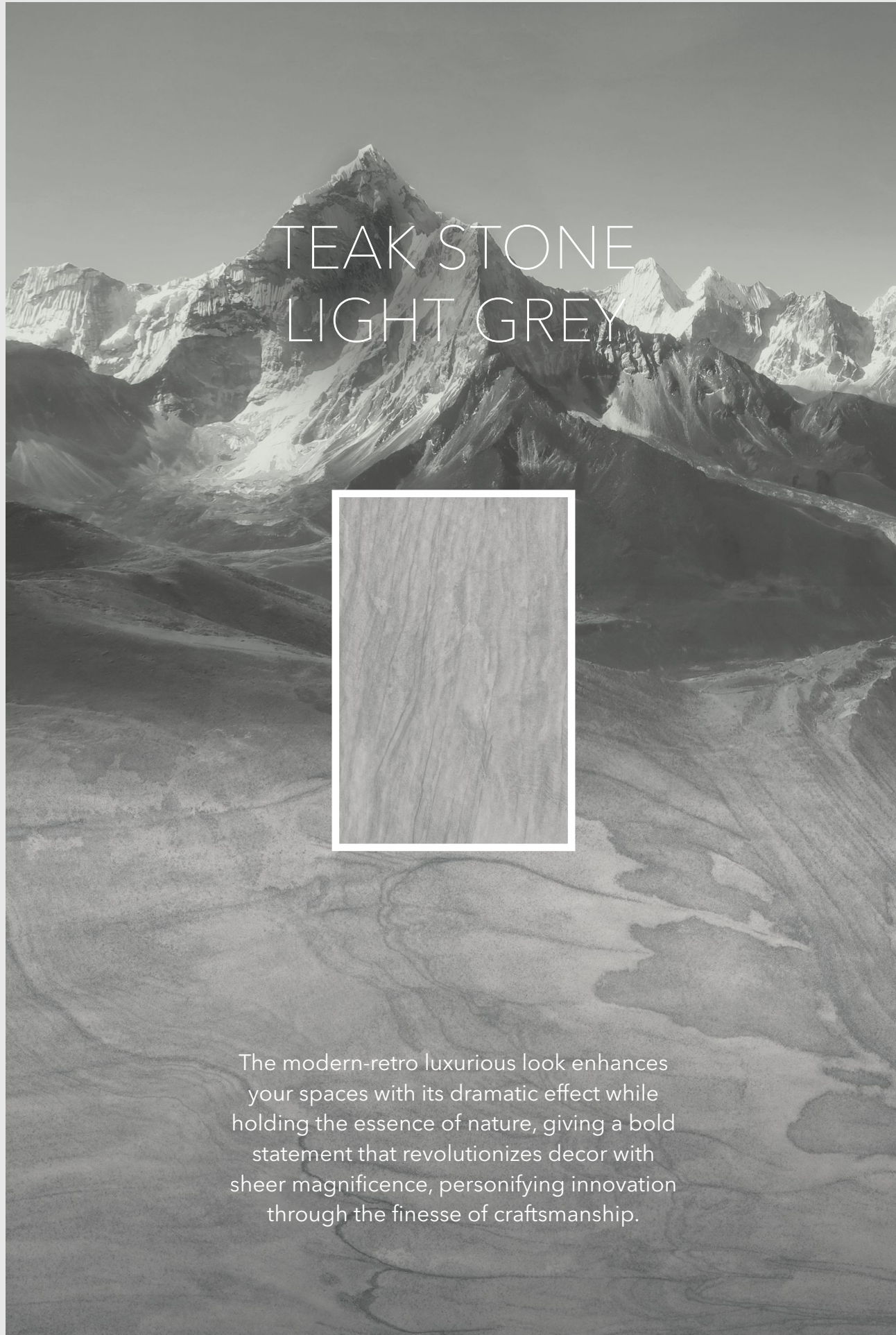

The modern-retro luxurious look enhances your spaces with its dramatic effect while holding the essence of nature, giving a bold statement that revolutionizes decor with sheer magnificence, personifying innovation through the finesse of craftsmanship.

TEAK STONE LIGHT GREY

Available Colors



Size **600x900mm** Surface **Matt**
Body Type **Grey** Random **9**

Available Sizes

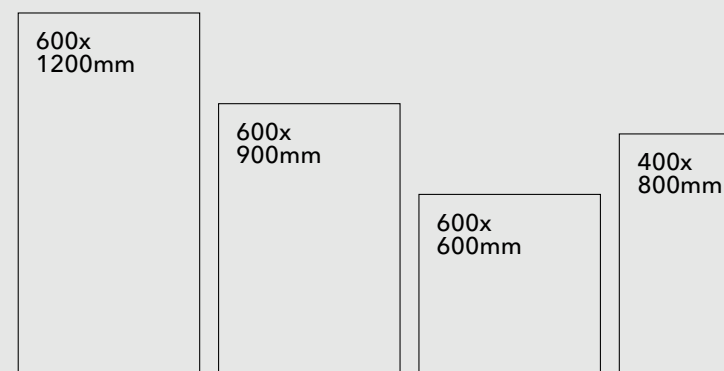



Floor - Amazon Beige - 600x900mm



AMAZON BEIGE

A timeless color and pattern; soothing, natural, and effortless drawing its inspiration from the unfathomable mountains and sand of the endless deserts. A color that blends in and makes your interiors stand out impressively.

AMAZON BEIGE

Available Colors



Size **600x900mm** Surface **Matt**
Body Type **Ivory** Random **5**

Available Sizes

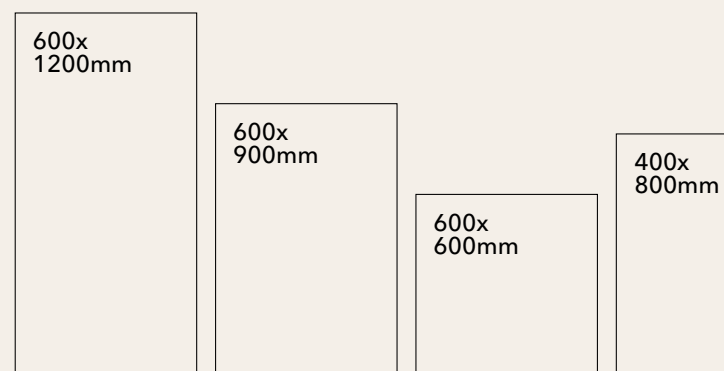

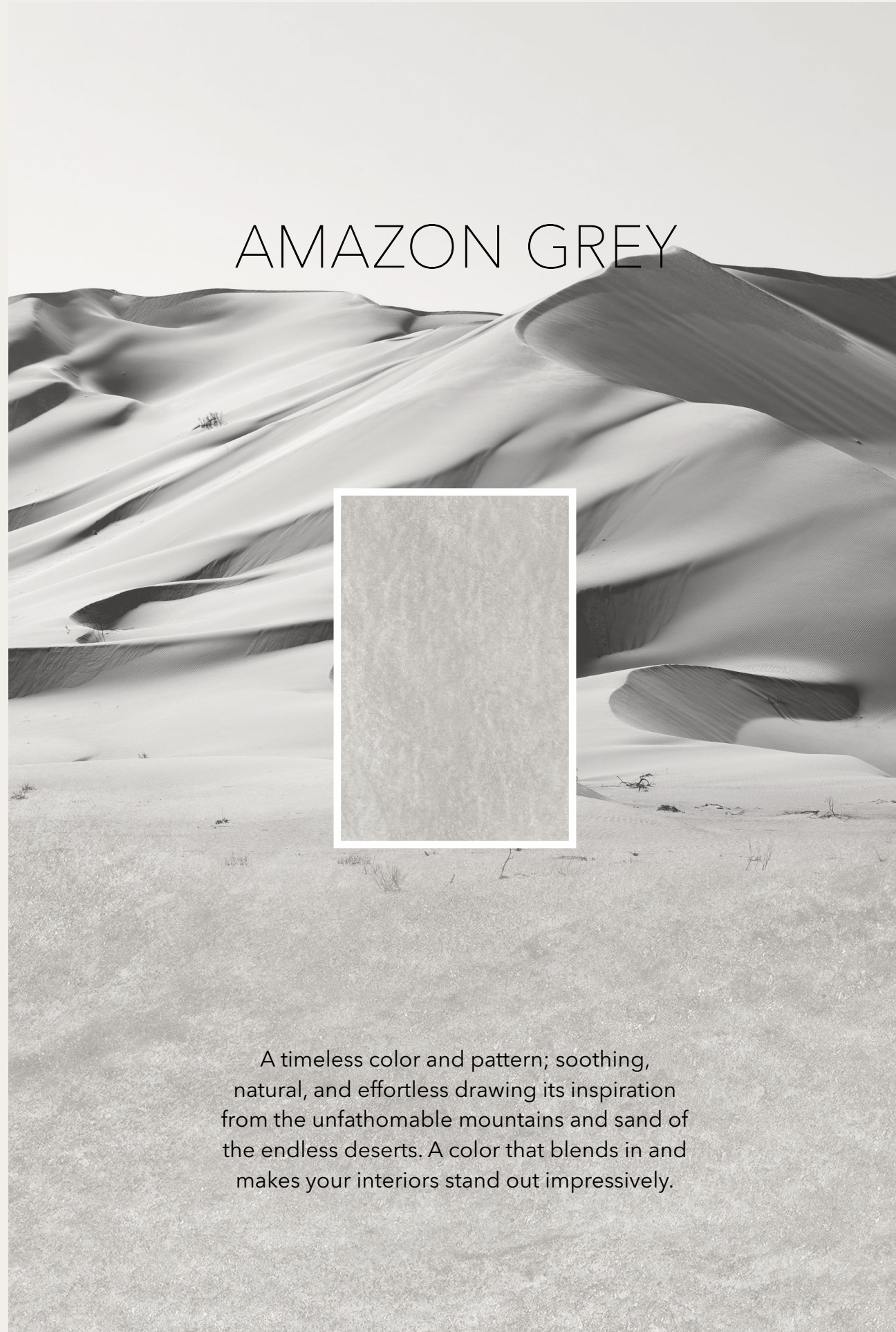

AMAZON GREY

A timeless color and pattern; soothing, natural, and effortless drawing its inspiration from the unfathomable mountains and sand of the endless deserts. A color that blends in and makes your interiors stand out impressively.

AMAZON GREY

Available Colors



Size **600x900mm** Surface **Matt**
Body Type **Grey** Random **5**

Available Sizes

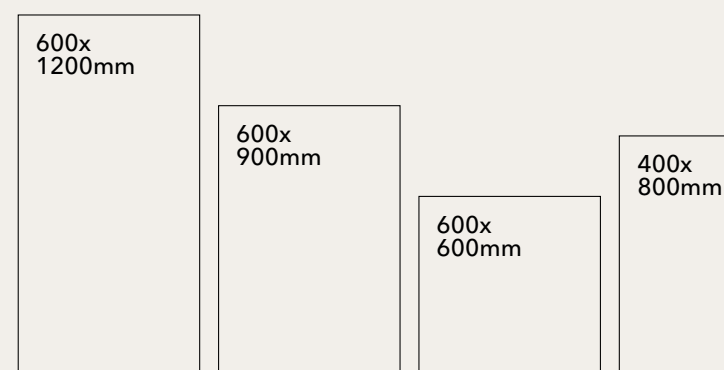

AMAZON NERO

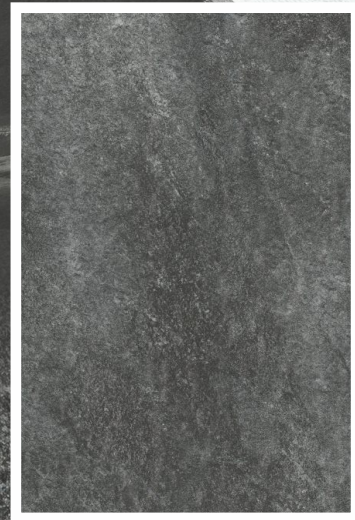

Presenting surfaces inspired by a moonless starlit sky sprinkled with the elegance of stars shining at an incomprehensible distance. The tiles feature a stern grey color for an astute and dominating ambiance in your spaces.

AMAZON NERO

Available Colors

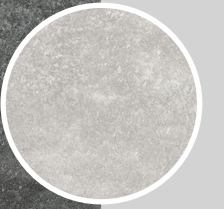
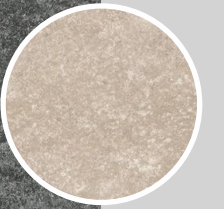
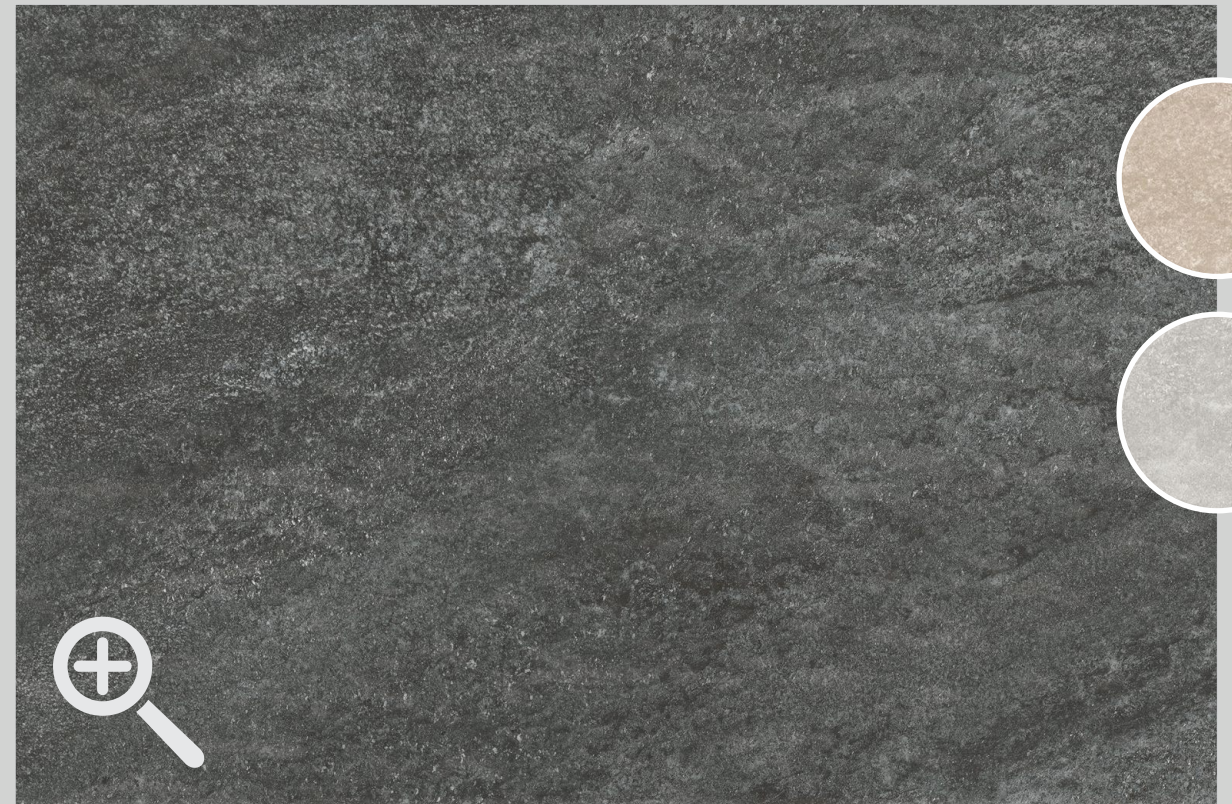

Size **600x900mm** Surface **Matt**
Body Type **Black** Random **5**

Available Sizes

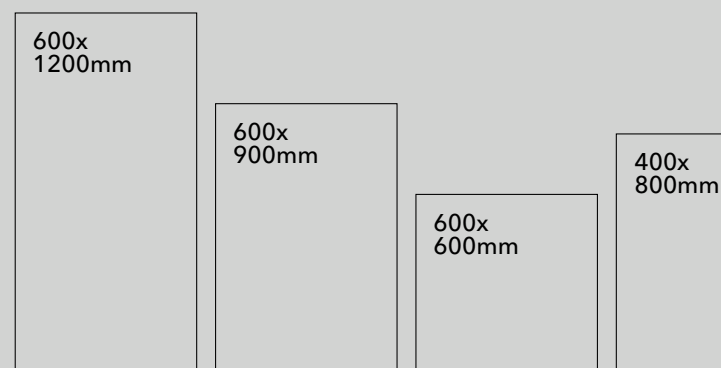



Floor - Evok Grey - 600x900mm

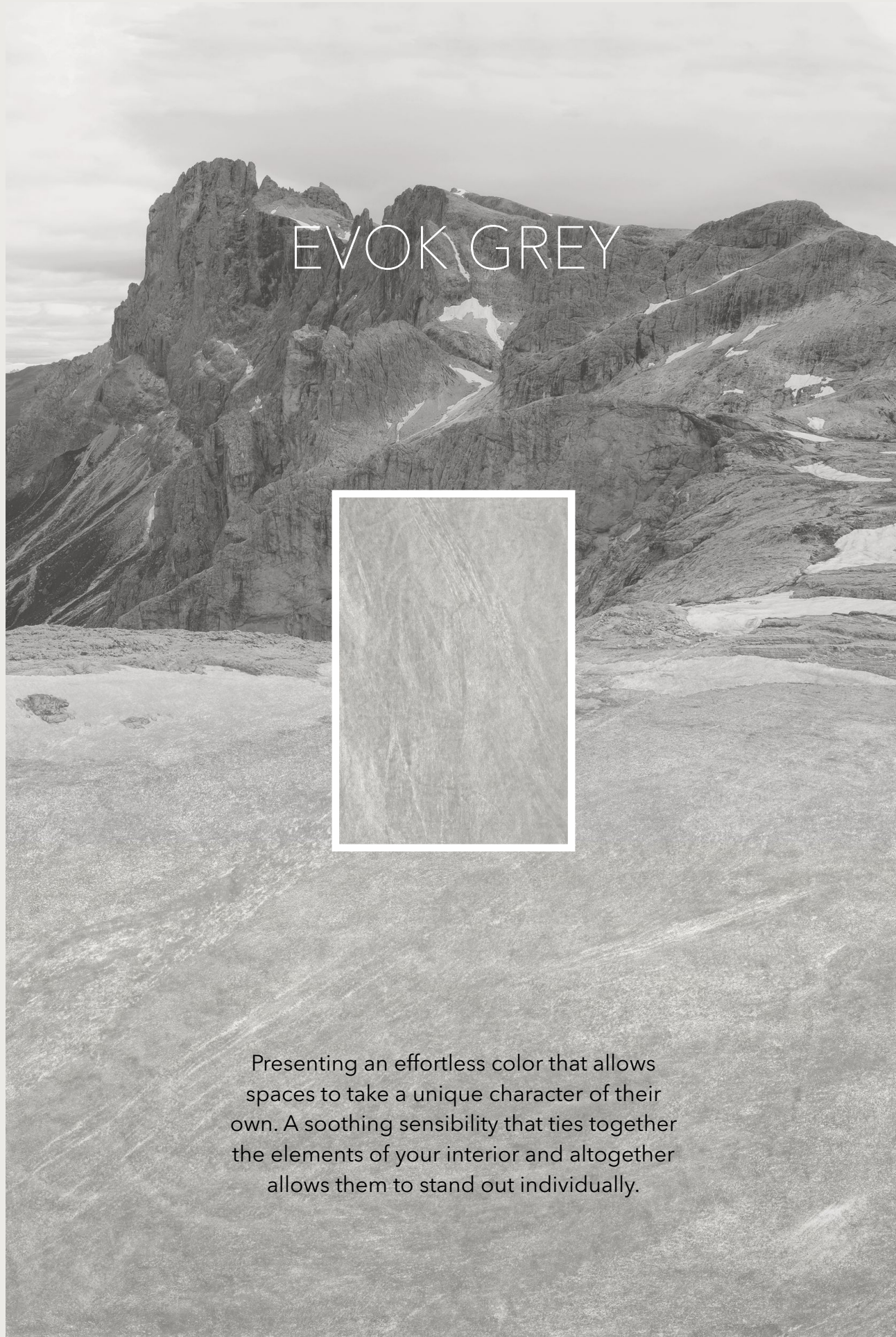

Presenting an effortless color that allows spaces to take a unique character of their own. A soothing sensibility that ties together the elements of your interior and altogether allows them to stand out individually.

EVOK GREY

Available Colors



Size **600x900mm** Surface **Matt**
Body Type **Grey** Random **9**

Available Sizes

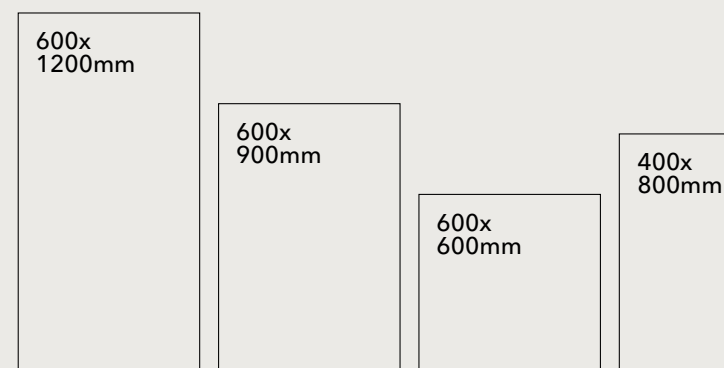



EVOK CONERET

Allow your spaces to dive deep into the dusky elegance of midnight darkness with the deep somber shade of tiles. Elegant, enchanting, and impressive, the color and patterns instill elegance unparalleled and close to nature.

EVOK CONCRETE

Available Colors



Size **600x900mm** Surface **Matt**
Body Type **Black** Random **7**

Available Sizes

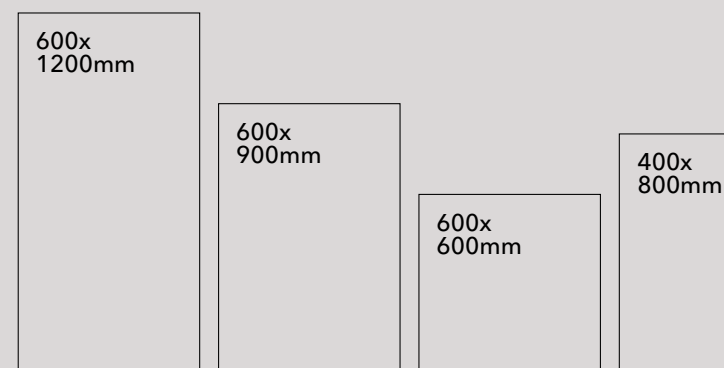



EVOK ANTHRECITE

Experience the sable beauty and the rich textures of the earth and its marvelous peaks and terrains on surfaces capturing the very essence and bringing it to you in an exclusive collection; a collection designed to breathe and embody nature.

EVOK ANTHRECITE

Available Colors



Size **600x900mm** Surface **Matt**
Body Type **Black** Random **9**

Available Sizes

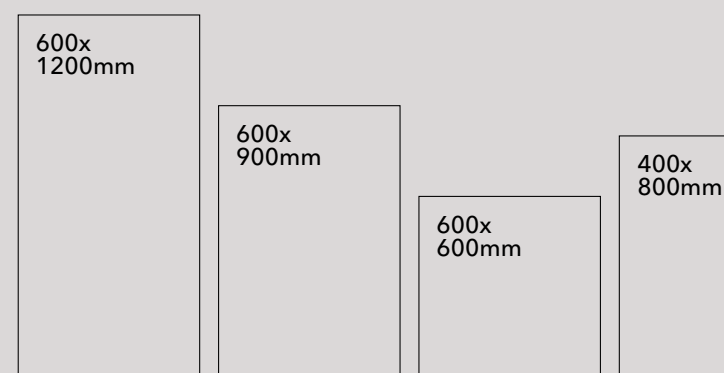



Floor - Kandla Grey - 600x600mm

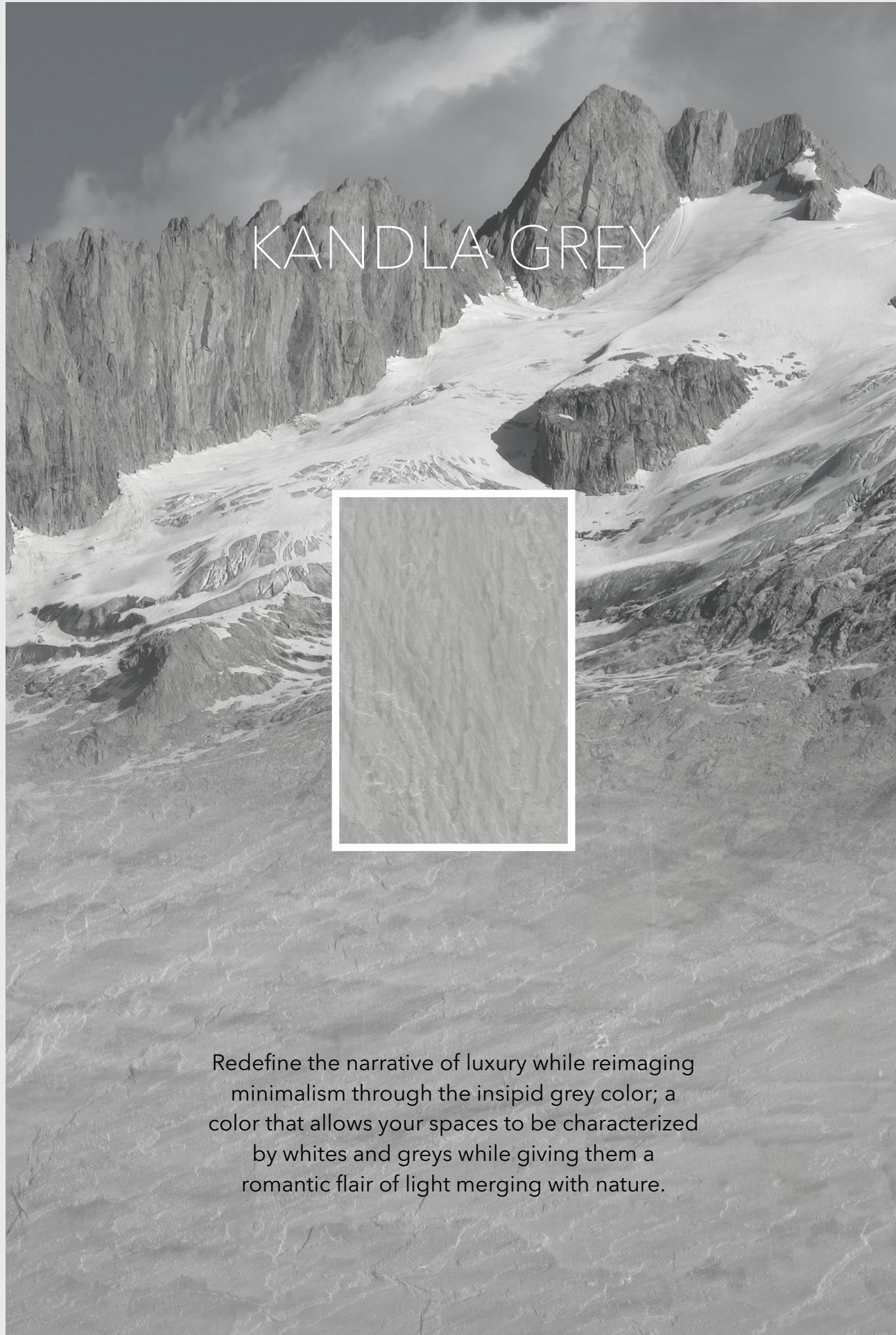

Redefine the narrative of luxury while reimagining minimalism through the insipid grey color; a color that allows your spaces to be characterized by whites and greys while giving them a romantic flair of light merging with nature.

KANDLA GREY



Size **600x900mm** Surface **Matt**
Body Type **Grey** Random **20**

Available Sizes

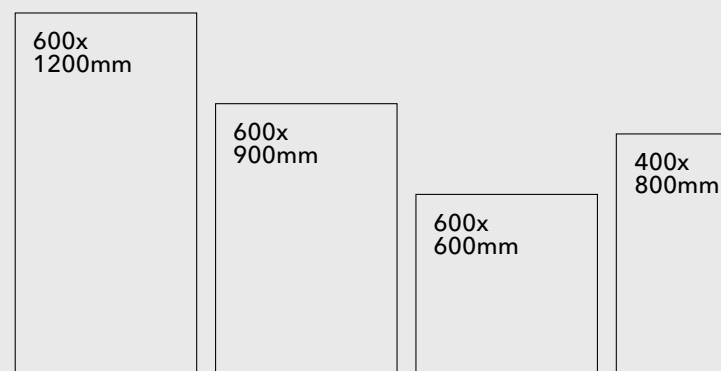



Floor - Earthcore Grey - 600x900mm

EARTHCORE GREY



Freedom and contact with nature are elements that will give your spaces a completely new and unique image. These surfaces are reminiscent of pale, old-world charm that bring together a range of inspirations, and unconstrained expression.

EARTHCORE GREY

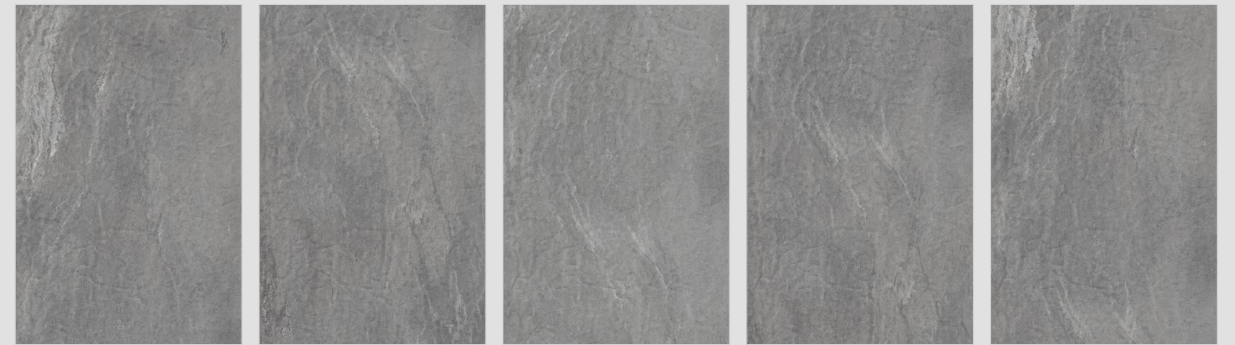

Size **600x900mm** Surface **Matt**
Body Type **Grey** Random **5**

Available Sizes

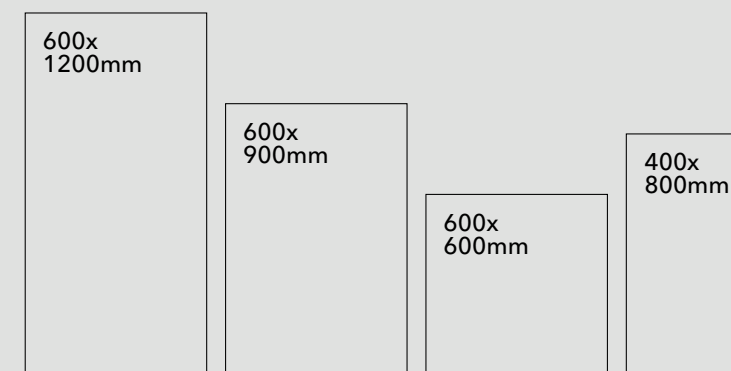



Floor - Dolce Beige - 600x600mm

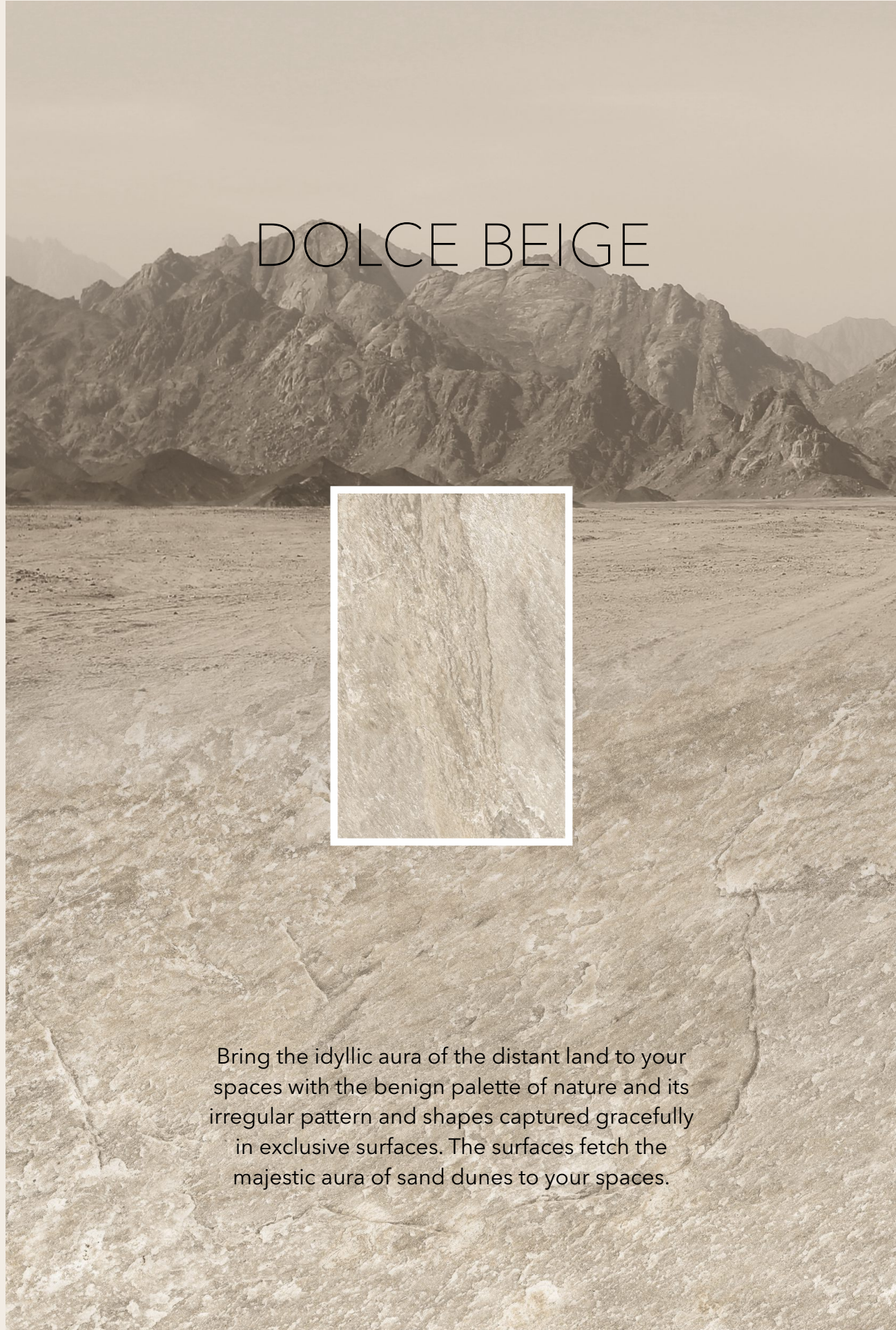

DOLCE BEIGE

Bring the idyllic aura of the distant land to your spaces with the benign palette of nature and its irregular pattern and shapes captured gracefully in exclusive surfaces. The surfaces fetch the majestic aura of sand dunes to your spaces.

DOLCE BEIGE

Available Colors



Size **600x900mm** Surface **Matt**
Body Type **Ivory** Random **8**

Available Sizes

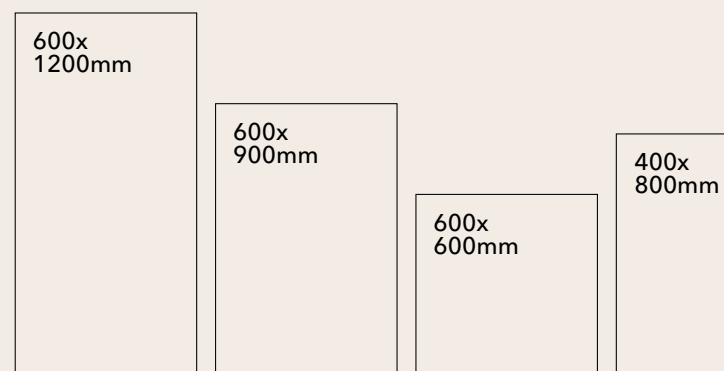

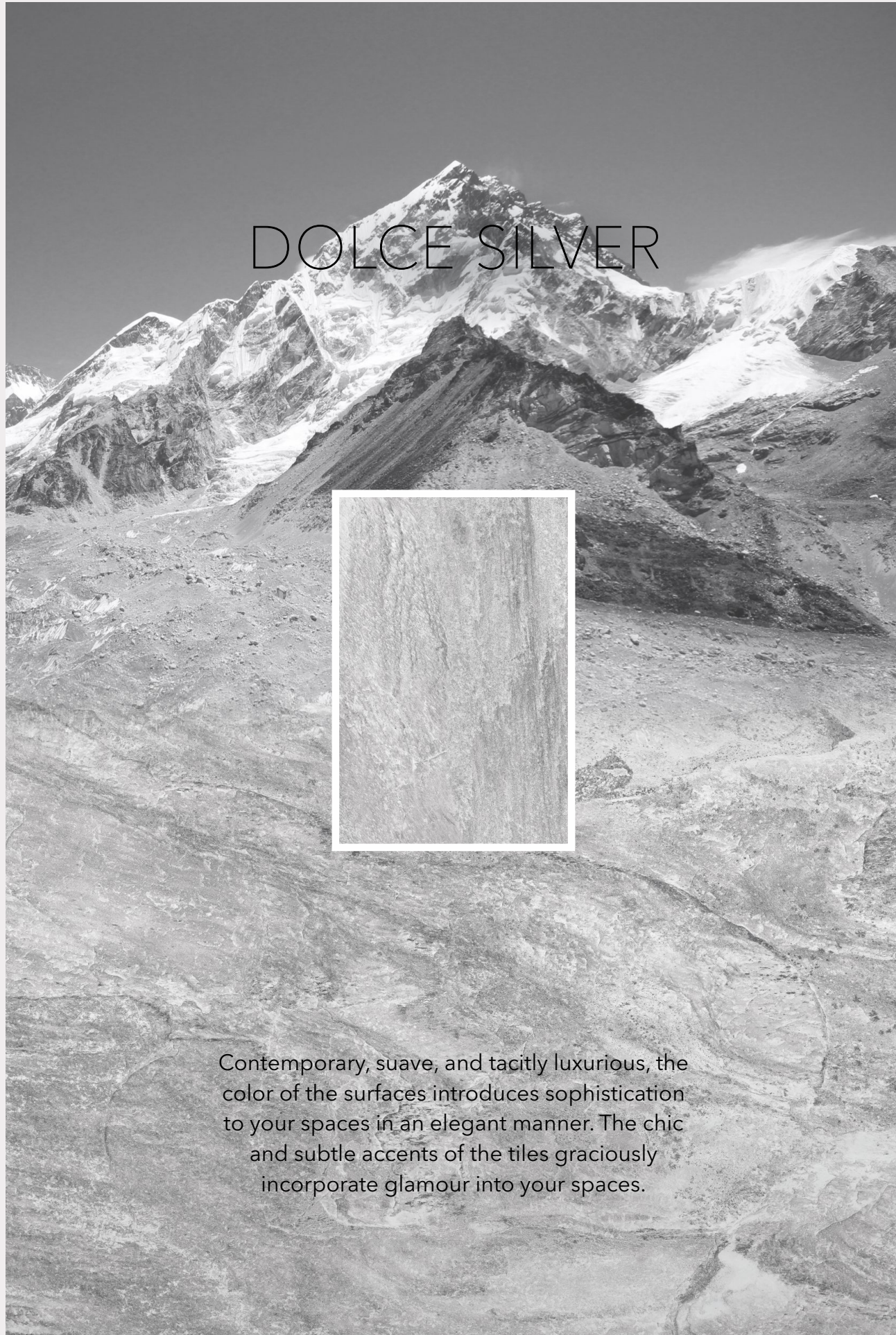

DOLCE SILVER

Contemporary, suave, and tacitly luxurious, the color of the surfaces introduces sophistication to your spaces in an elegant manner. The chic and subtle accents of the tiles graciously incorporate glamour into your spaces.

DOLCE SILVER

Available Colors

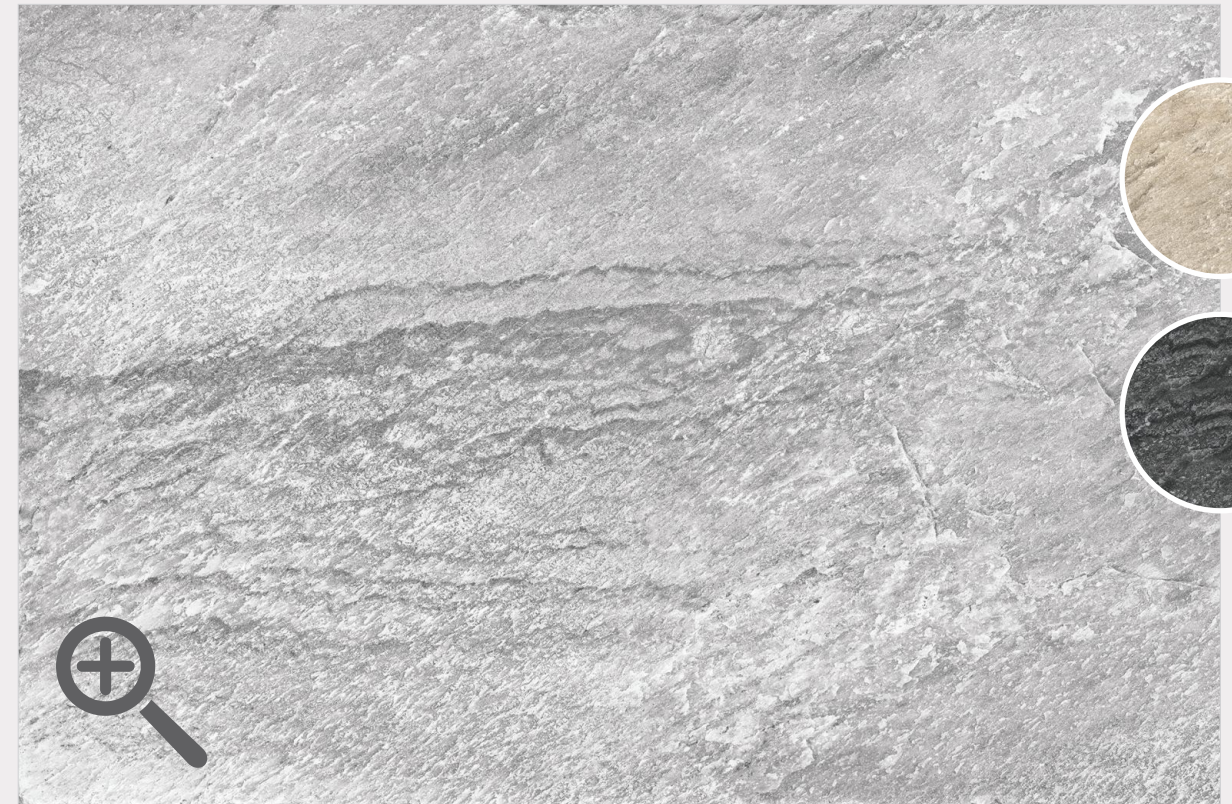

Size **600x900mm** Surface **Matt**
Body Type **Grey** Random **8**

Available Sizes

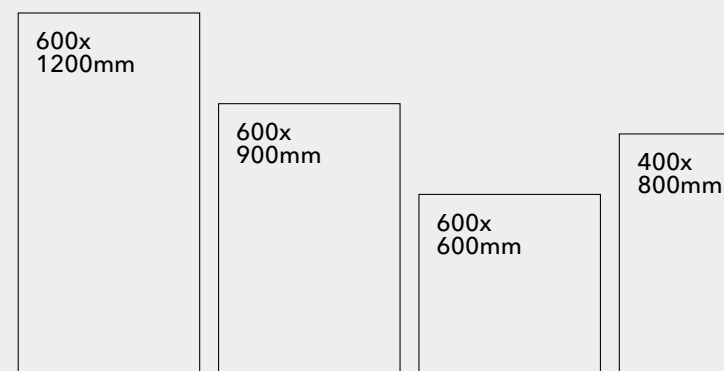

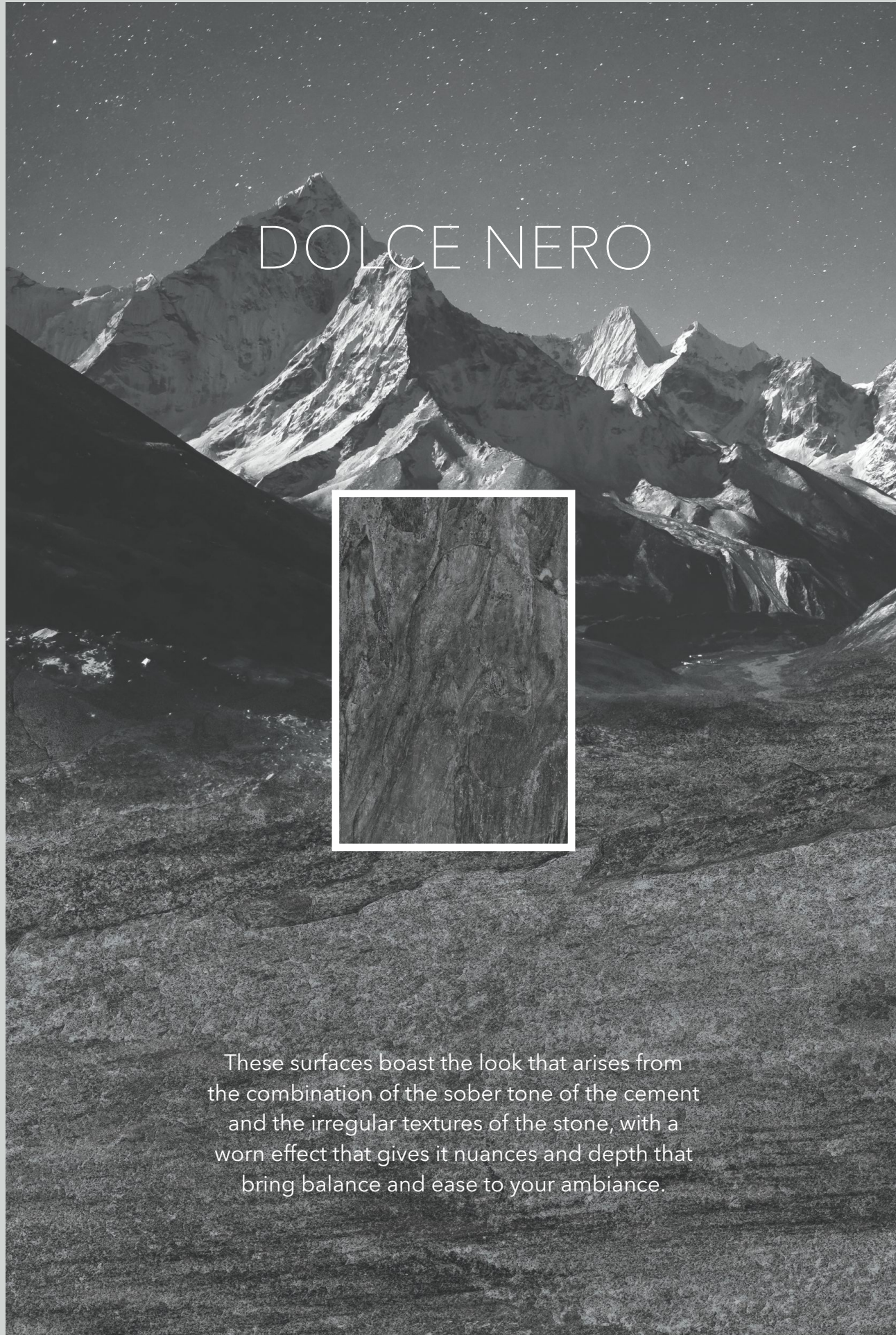

These surfaces boast the look that arises from the combination of the sober tone of the cement and the irregular textures of the stone, with a worn effect that gives it nuances and depth that bring balance and ease to your ambiance.

DOLCE NERO

Available Colors

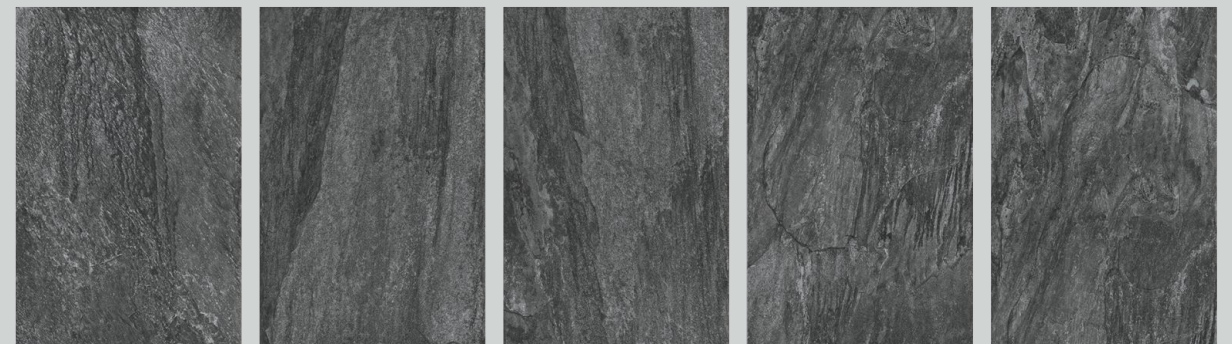
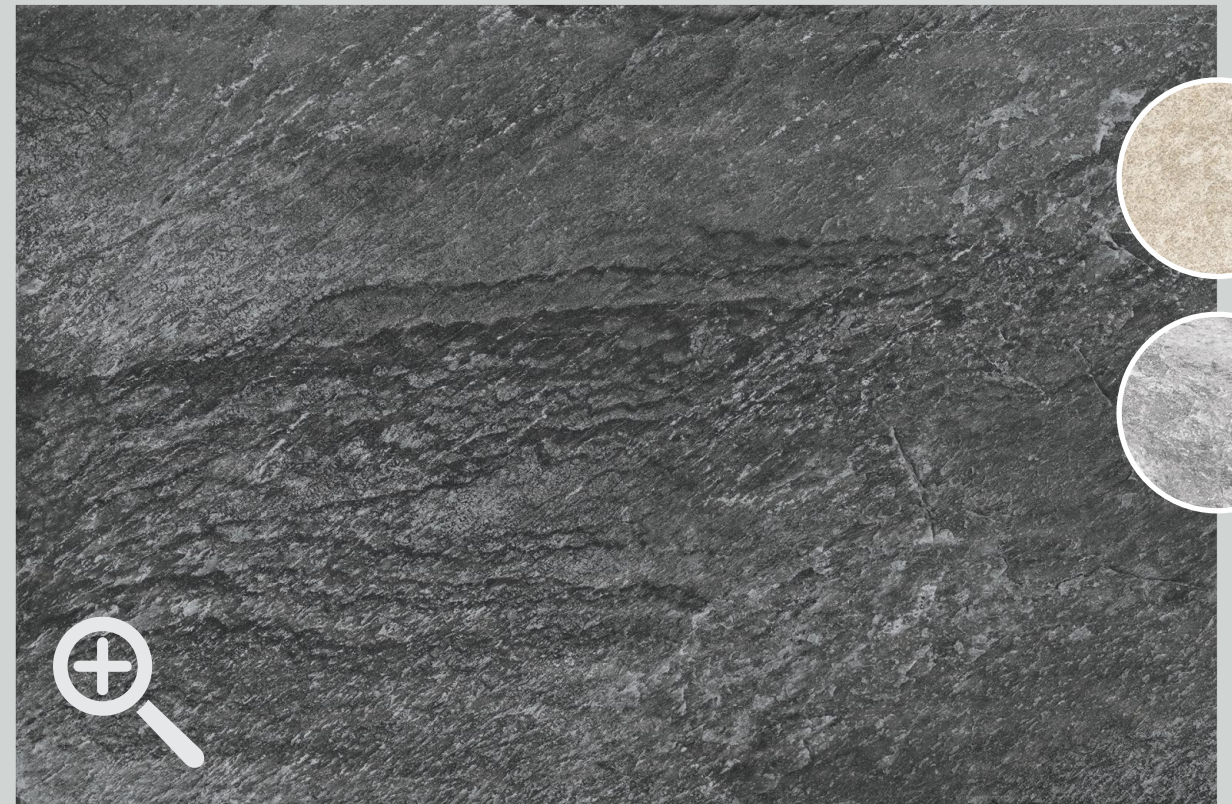

Size **600x900mm** Surface **Matt**
Body Type **Black** Random **8**

Available Sizes

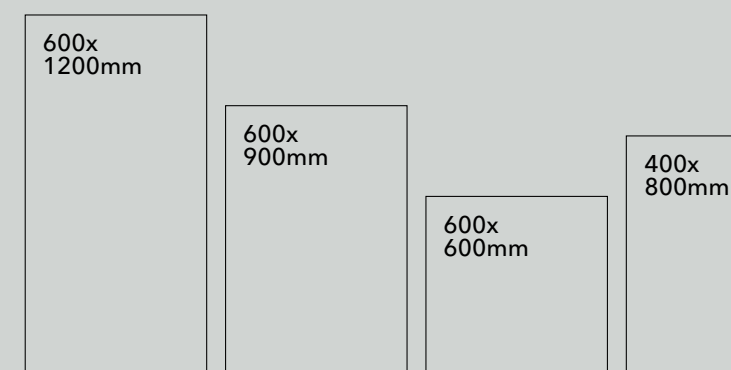



Floor - Madeira Beige - 600x900mm



MADEIRA BEIGE

These surfaces give color to history with a journey through time and space paying tribute to the monumentality and phenomenality of nature at its finest. The richness of patterns creates interesting compositions with striking designs.

MADEIRA BEIGE

Available Colors



Size **600x900mm** Surface **Matt**
Body Type **Ivory** Random **3**

Available Sizes

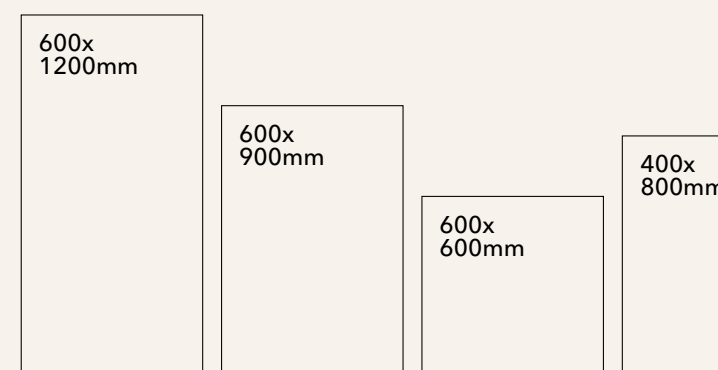

MADEIRA GREY

Discover the enigma and depth of design that reflects the intense tones and textures that enchant the eye with a richness of details. Inspired by nature, the collection reinterprets and experiments with bold and aesthetic canons.

MADEIRA GREY

Available Colors

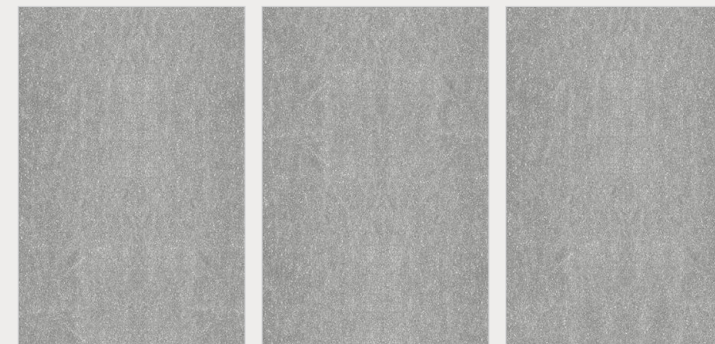
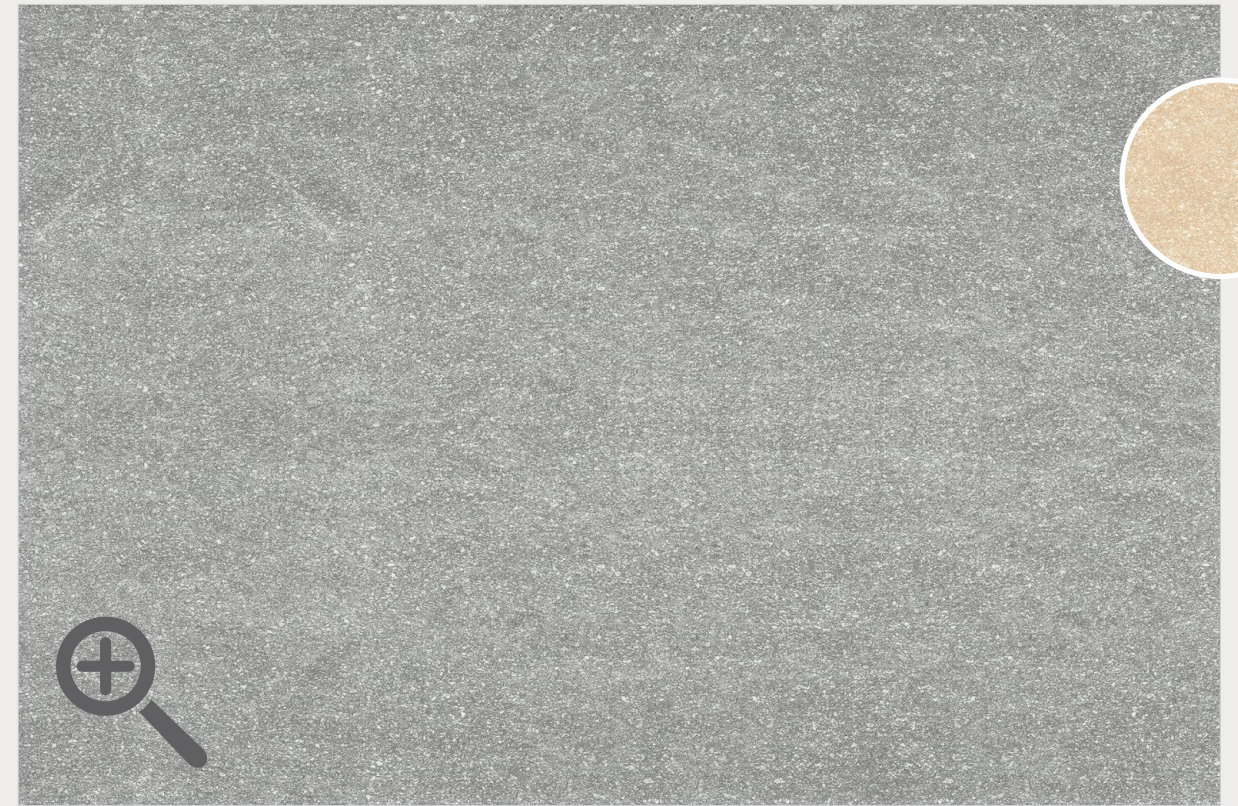

Size **600x900mm** Surface **Matt**
Body Type **Grey** Random **3**

Available Sizes

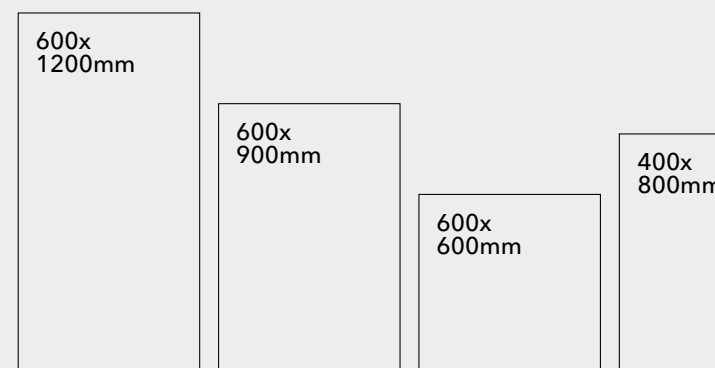



Floor - River Graphite - 600x900mm

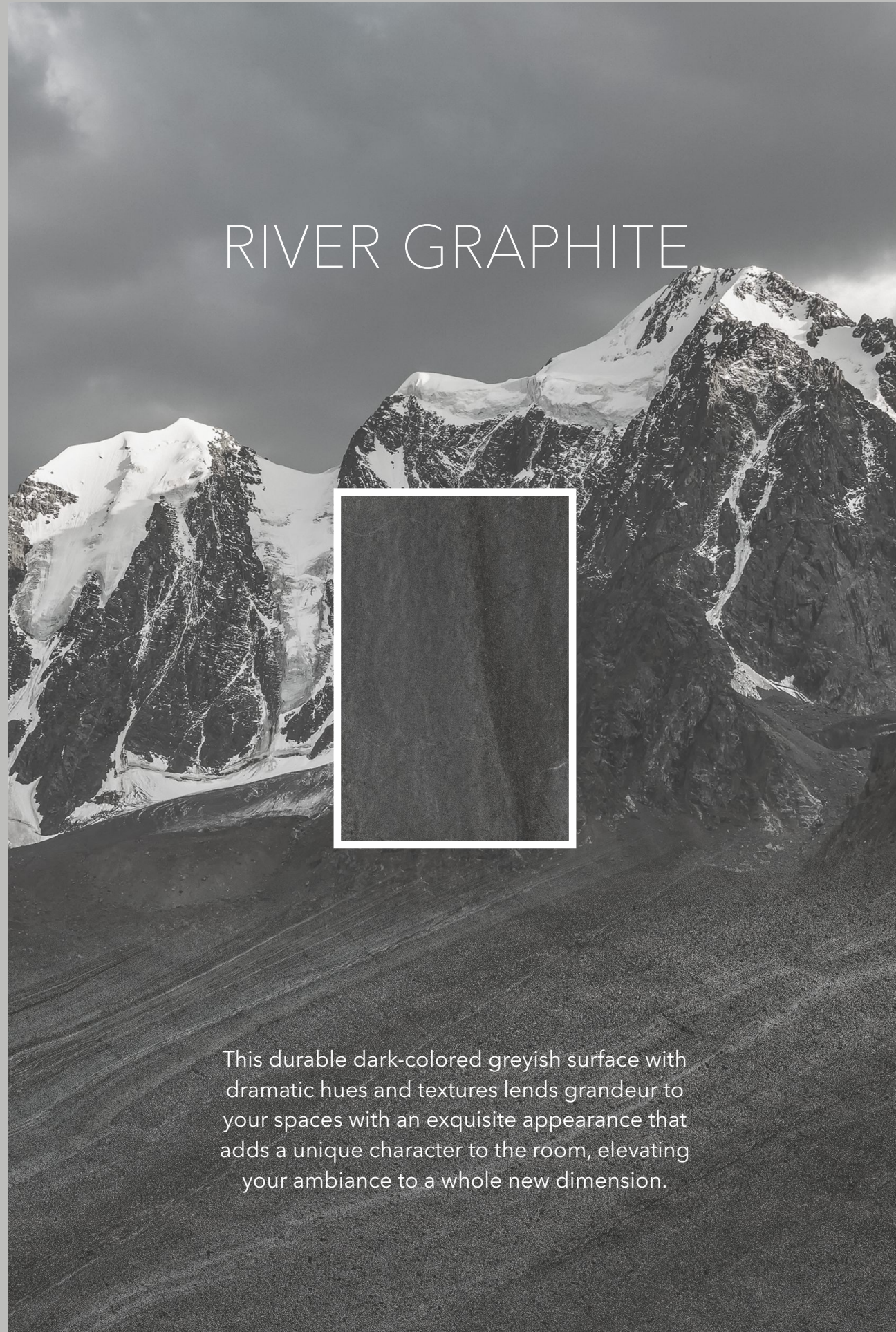

RIVER GRAPHITE

This durable dark-colored greyish surface with dramatic hues and textures lends grandeur to your spaces with an exquisite appearance that adds a unique character to the room, elevating your ambiance to a whole new dimension.

RIVER GRAPHITE

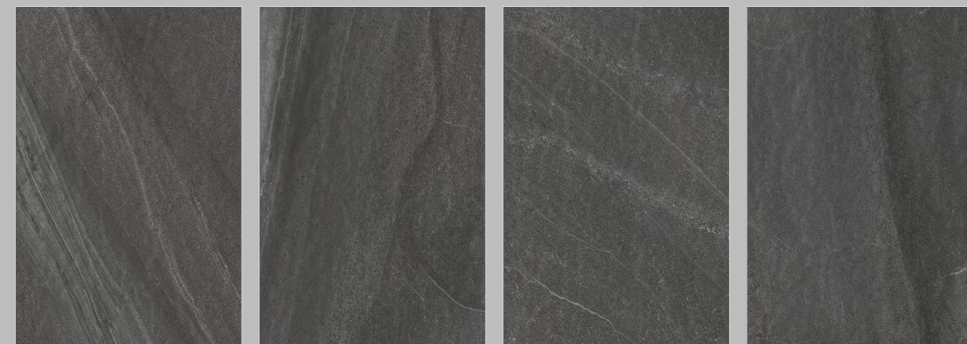

Size **600x900mm** Surface **Matt**
Body Type **Black** Random **4**

Available Sizes

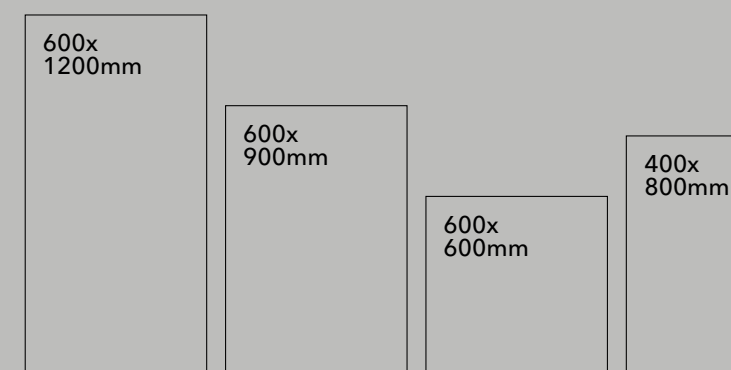



Floor - Sea Sand Gray - 600x900mm, 600x600mm, 400x800mm

SEA SAND BEIGE



Enjoy the natural feel in your spaces with soft hues and textures that evoke a contemporary version of the rural charm ushering in warmth and beauty that give your expanse a distinctive aura of heart-warming openness.

SEA SAND BEIGE

Available Colors

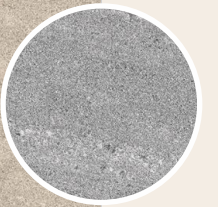

Size **600x900mm** Surface **Matt**
Body Type **Ivory** Random **10**

Available Sizes

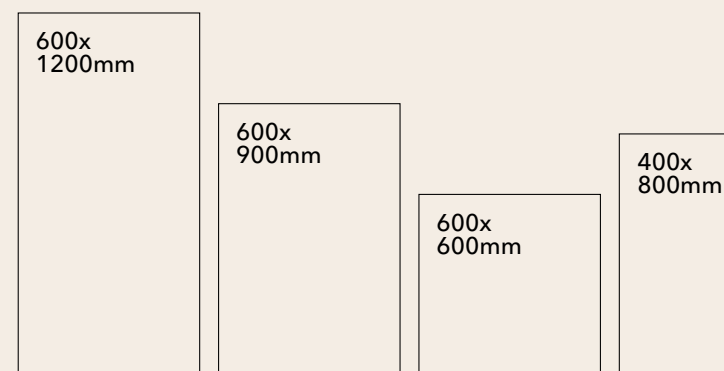

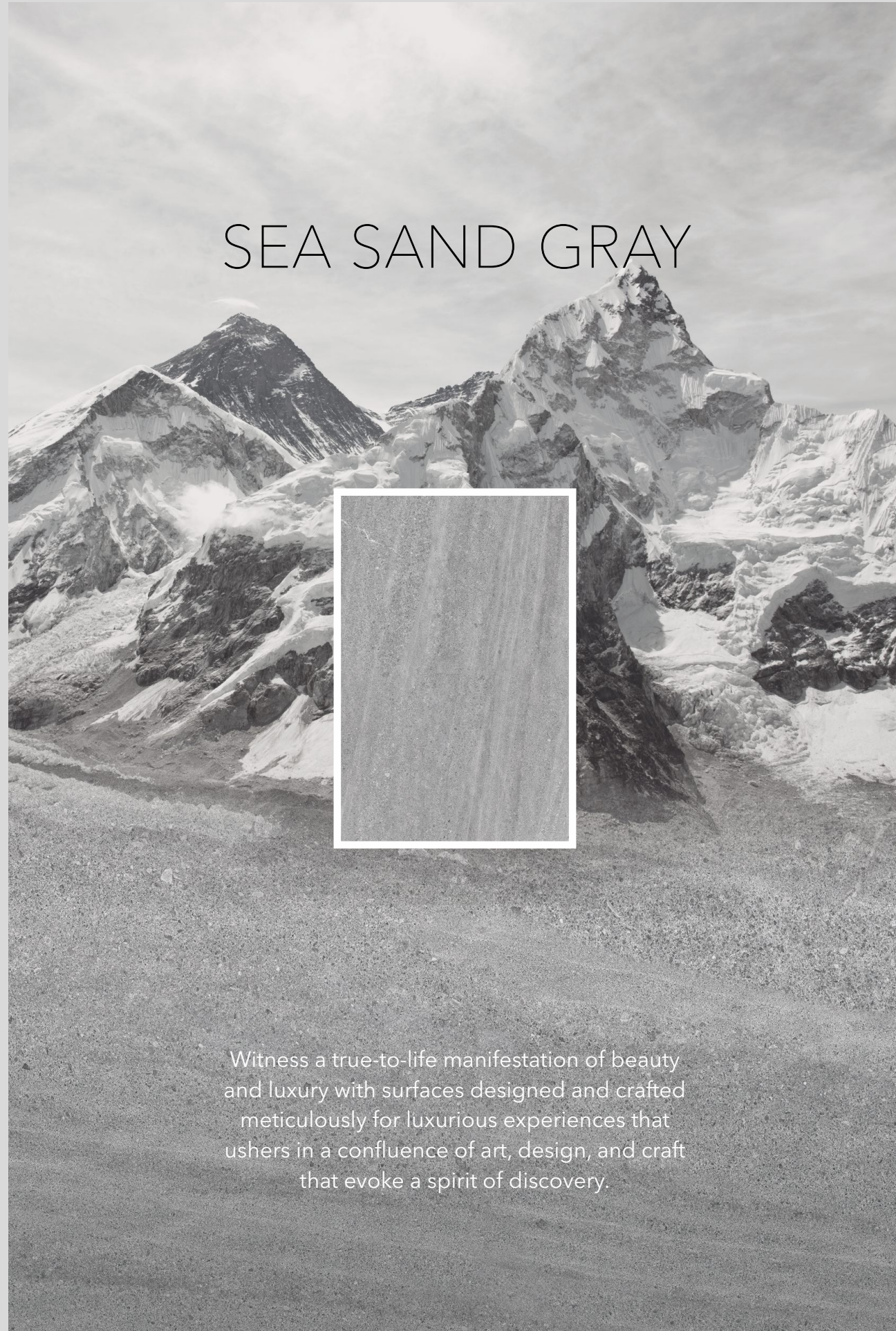

SEA SAND GRAY



Witness a true-to-life manifestation of beauty and luxury with surfaces designed and crafted meticulously for luxurious experiences that ushers in a confluence of art, design, and craft that evoke a spirit of discovery.

SEA SAND GRAY

Available Colors



Size **600x900mm** Surface **Matt**
Body Type **Grey** Random **10**

Available Sizes

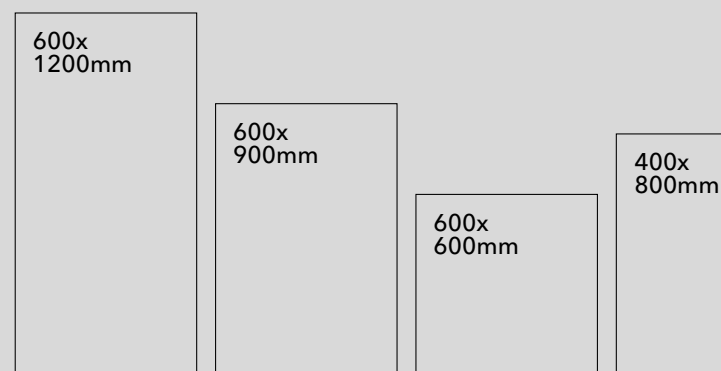

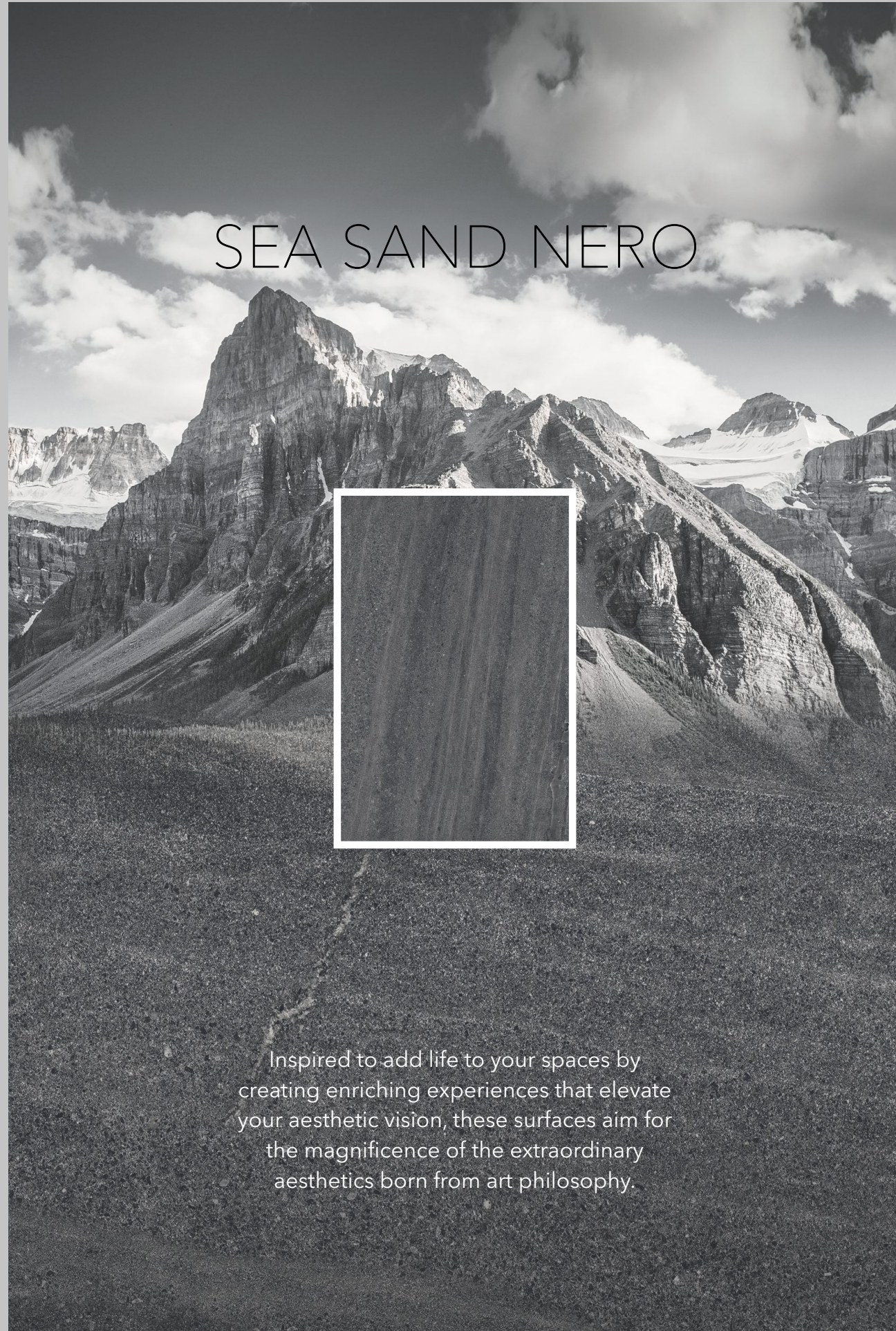

SEA SAND NERO

Inspired to add life to your spaces by creating enriching experiences that elevate your aesthetic vision, these surfaces aim for the magnificence of the extraordinary aesthetics born from art philosophy.

SEA SAND NERO

Available Colors



Size **600x900mm** Surface **Matt**
Body Type **Black** Random **10**

Available Sizes

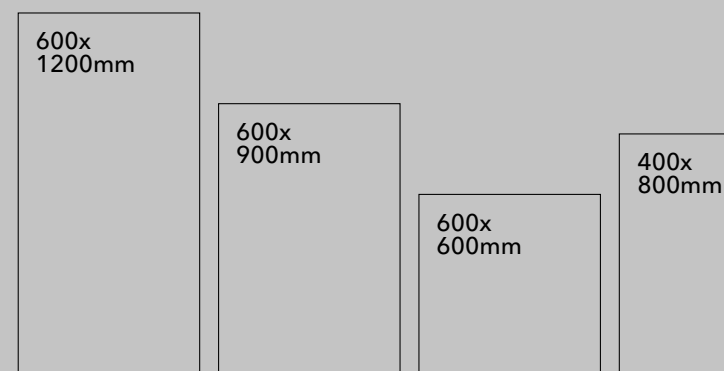



Floor - Volga Grey - 600x600mm

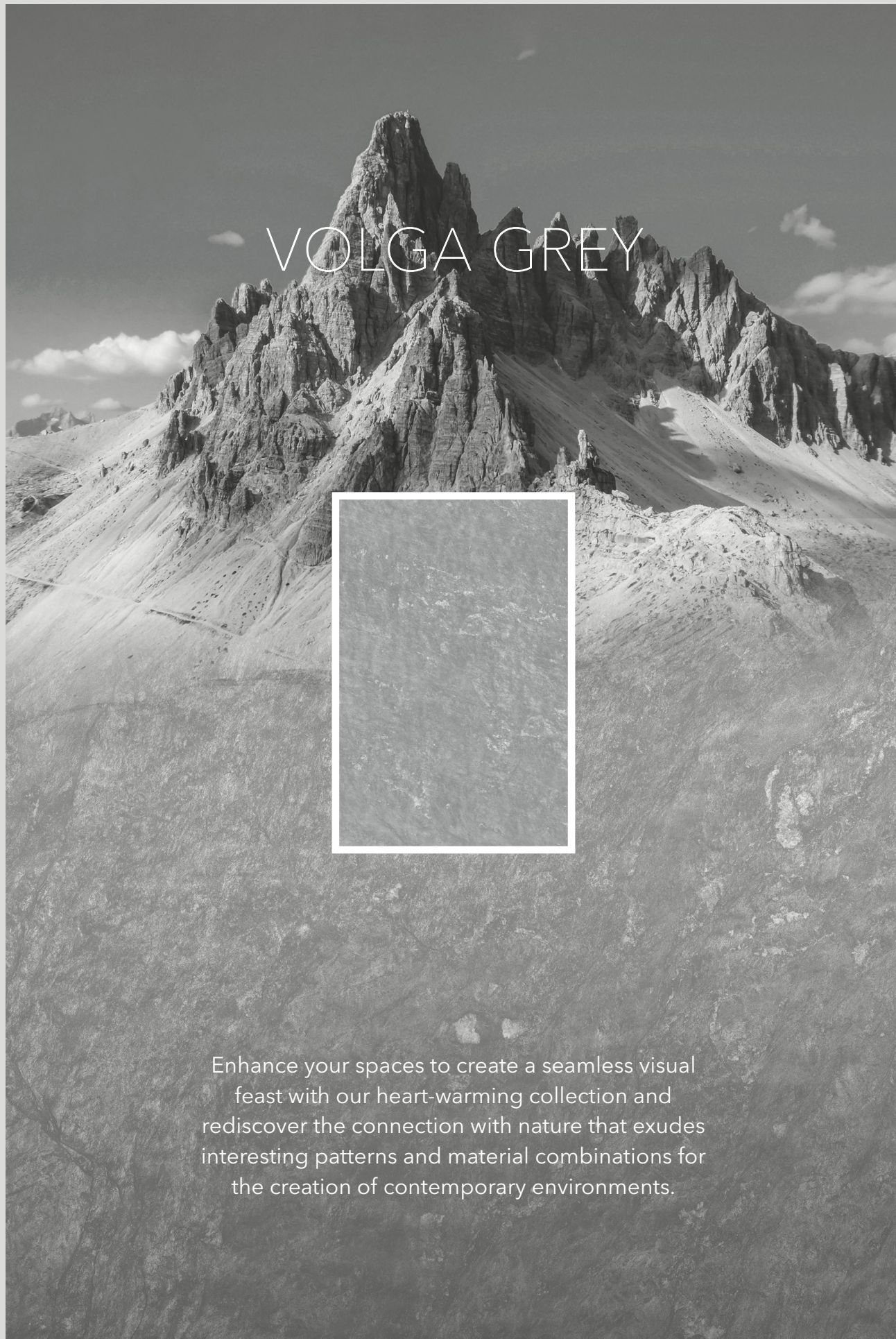

Enhance your spaces to create a seamless visual feast with our heart-warming collection and rediscover the connection with nature that exudes interesting patterns and material combinations for the creation of contemporary environments.

VOLGA GREY

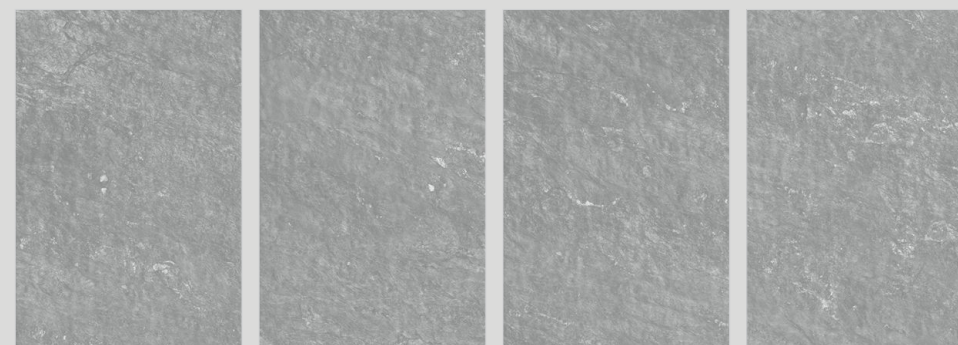
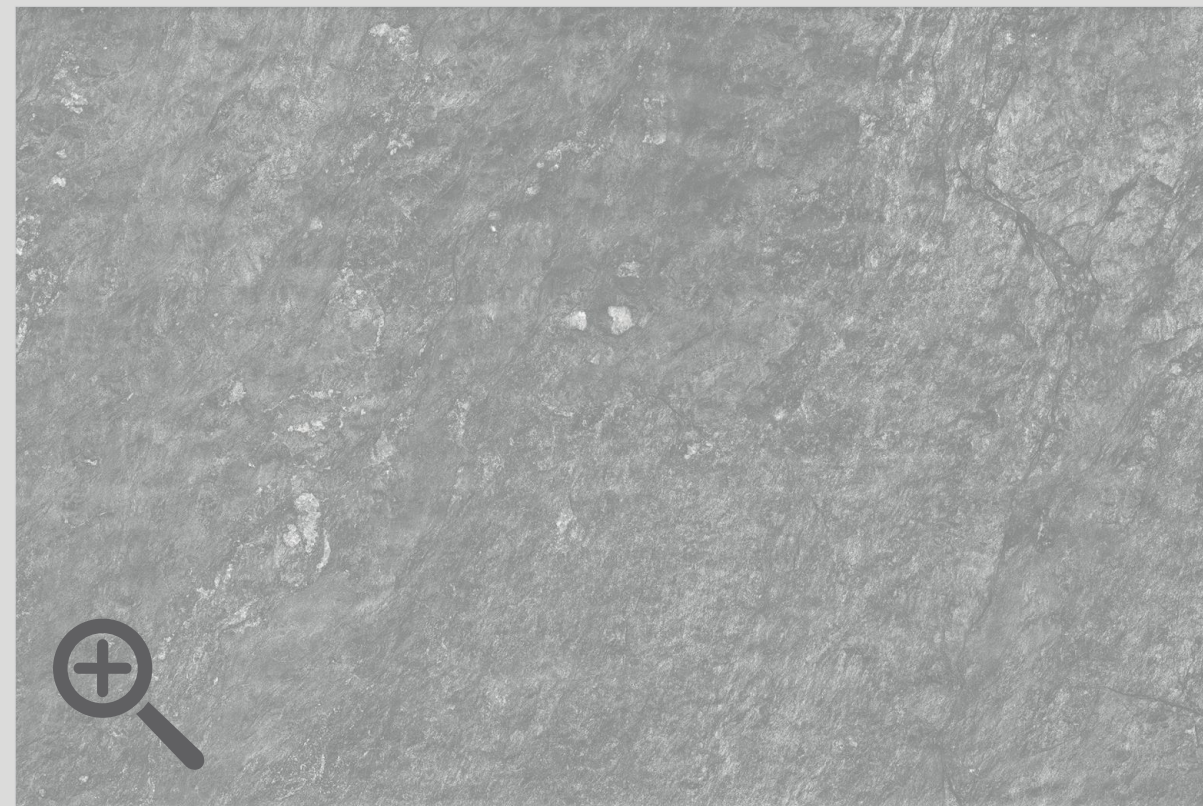

Size **600x900mm** Surface **Matt**
Body Type **Grey** Random **4**

Available Sizes

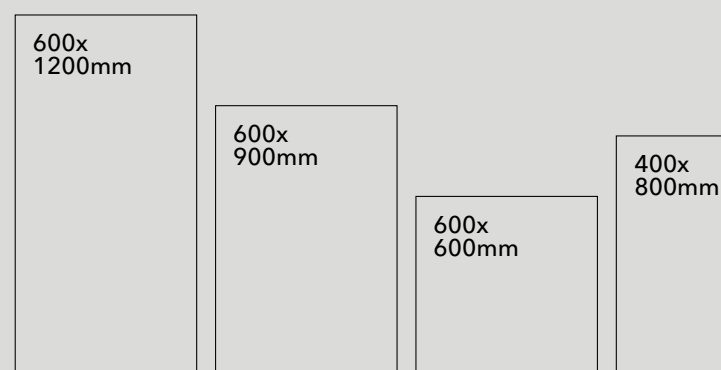

PORCELAIN STONEWARE TILE 20MM FOR OUTDOOR FLOORING

20mm outdoor porcelain stoneware is the product with the highest technical performance, ideal for flooring in an outdoor environment without the risk of breakage and without interrupting the continuity between interior and exterior spaces. Resistant to frost and thermal

shock, it has intensified anti-slip characteristics and is easy to clean. The perfect union between high technical performance and aesthetics helps maintain the material and color unchanged over time, guaranteeing long-lasting durability.

VERSATILE



**EASY TO LAY,
REMOVE AND REUSE**



**COLORS REMAIN
STABLE OVER TIME**

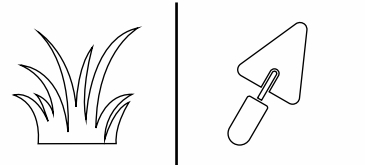

CAN BE INSTALLED WITH DIFFERENT LAYING SYSTEMS

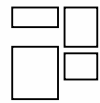

**MULTIPLE AESTHETIC
VARIATIONS SEAMLESSLY
COMBINE OUTDOOR AND
INDOOR FLOORING**



**ATTENTION TO DETAIL
AND SPECIAL PIECES FOR
AESTHETIC RESULTS THAT
MAKE A GREAT IMPACT**

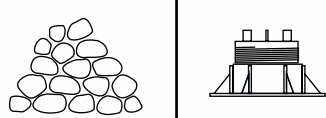

RESISTANT



FROST-RESISTANT



FIRE-PROOF



**RESISTANT TO STAINS,
ACIDS AND CHEMICAL AGENTS**



RESISTANT TO SALT



**RESISTANT
TO MOULD AND BACTERIA**

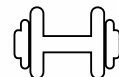

**HIGHLY RESISTANT
TO HEAVY LOADS**



**HIGH RESISTANCE
TO THERMAL SHOCK**

FUNCTIONAL



NON-SLIP SURFACES

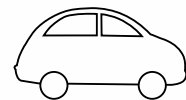

**RESISTANT TO VEHICULAR
PASSAGE IF APPLIED TO A
SCREED**



ECO-FRIENDLY



LEED COMPLIANT



EASY TO CLEAN

ECO-FRIENDLY

INTENDED USES

Owing to the possibility of installing it dry (on grass, sand, gravel, and elevated floors) the 20mm porcelain outdoor tile collection is the

most versatile solution for exterior floors in residential and public areas.

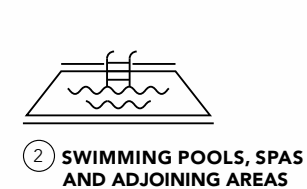
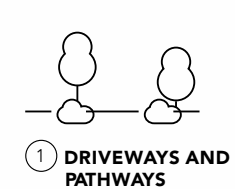
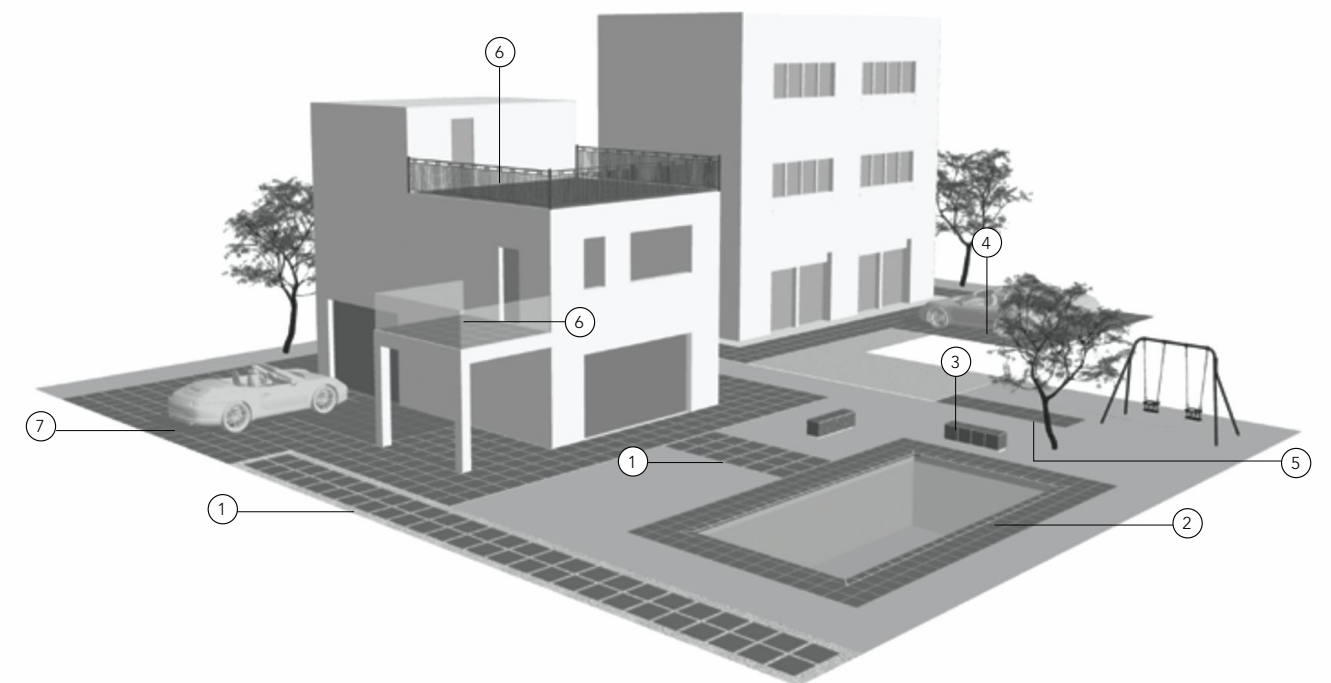

LAYING SOLUTIONS

Outdoor porcelain 20mm tiles are an innovative solution that is very versatile due to the numerous laying possibilities they offer: dry

installation on grass, gravel, or sand, screed with adhesive, and elevated floor installation.

DRY INSTALLATION ON GRASS



a. Easy to lay, adjust, and move. An ideal solution for public parks and private gardens.

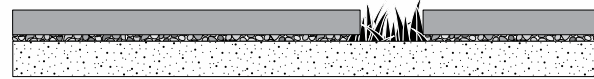

DRY INSTALLATION ON GRAVEL / SAND

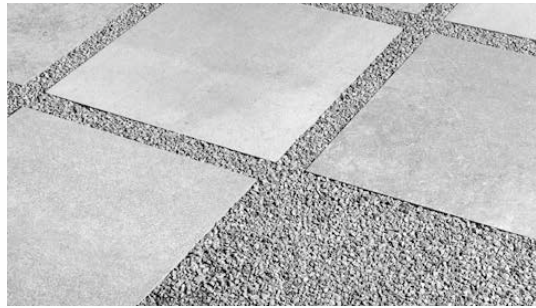

b. Easy to lay, adjust, and move. Boasts ideal aesthetic features to enhance contemporary buildings.

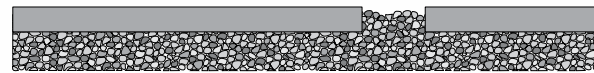

INSTALLATION ON SCREED WITH ADHESIVE



c. Build resilient and durable outdoor spaces, pathways, driveways, and more with the installation of 20mm tiles on screed with adhesive.

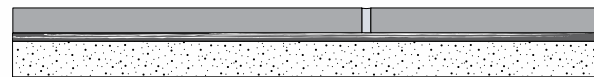

ELEVATED FLOOR INSTALLATION



d. Easily removable, inspectable, and reusable. Ideal to be applied with different kinds of support and is apt for concealing wiring pipes, and more with accessibility.

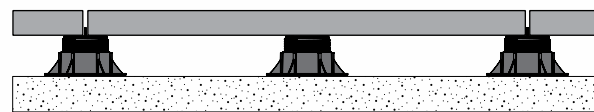

CAUTION

- When carrying out an elevated floor installation it is recommended to check the intended use and to follow the installation instructions.
- In the case of external dry installation, the force of the wind, in particular types of applications or geographical locations, can cause the lifting of the tiles. It is recommended that the designer/client always check the suitability of the installation system selected according to local regulations in force. Failure to follow the above recommendations may result in misuse of the product and cause injury to persons and/or damage to property.

DRY INSTALLATION ON GRASS

To create a pathway with stepping stones, first of all, it is important to determine the number of steps necessary for the entire path, making sure that the tiles are positioned equidistantly. So as to obtain maximum stability, it is recommended to

dig out about 5/8cm from the soil, and then place a fine layer of gravel. Compact the substrate and then position the tile. To allow the turf to grow well, it is advisable to leave a gap of at least 10cm between one tile and another.

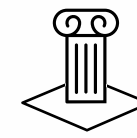

SAFE AND STABLE



LONG-LASTING



EASY TO CLEAN



DRAINS

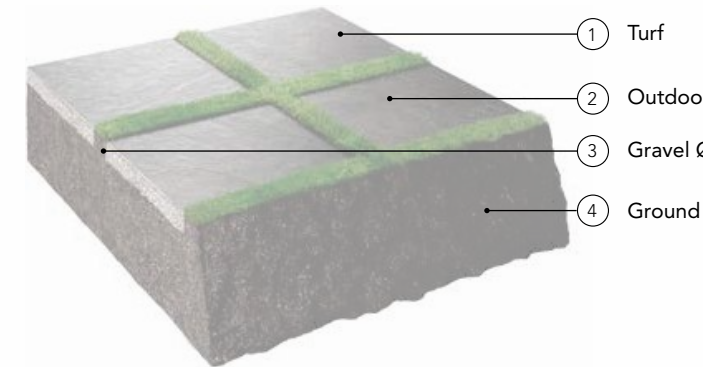

IT IS GOOD PRACTICE TO LAY THE SURFACE OF THE TILES IN LINE WITH THE TURF: THIS WAY THERE IS NO RISK OF DAMAGING THE LAWN MOWERS.

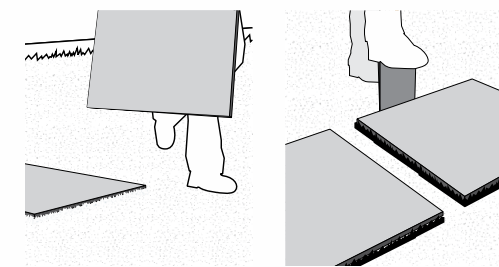

1/2

To determine the correct sizing and positioning of the flooring, place the tiles on the ground and carefully position them equidistant from each other. Mark the perimeter of the tile using a spade in the soil.

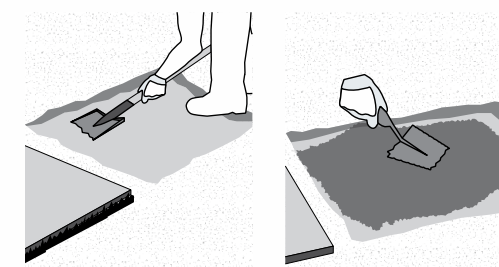

3/4

Remove the turf and dig out about 5cm of soil. Form a stable and uniform substrate using fine gravel (grain size 4/8mm).

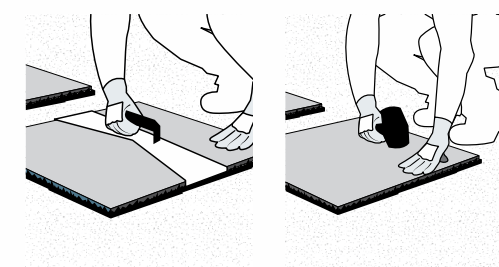

5/6

Lay the tile, so as to have an approximately 0.5cm level difference, between the tile and the ground. To simplify tile installation it is possible to use suitable tile installation handles. Knock the tile along the edges with a rubber hammer until it is at the same level as the turf.

CAUTION

The application layers proposed are to be taken as an indication, and have the sole purpose of showing how to obtain a correct flooring.

DRY INSTALLATION ON GRAVEL / SAND

For installation on sand it is good to remember to place a geotextile on the gravel, on which to spread out a layer (from 2 to 5cm thick) of dry sand with a grain size of 0/2mm. It is necessary to compact the sand with a vibro-compacting plate

before proceeding with the installation of the tiles. For particular uses and for stressful loads, it is advisable to consult a technician in order to calculate precisely the thicknesses of the various layers of the substrate.

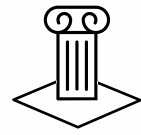

SAFE AND STABLE



LONG-LASTING

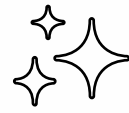

EASY TO CLEAN



DRAINS

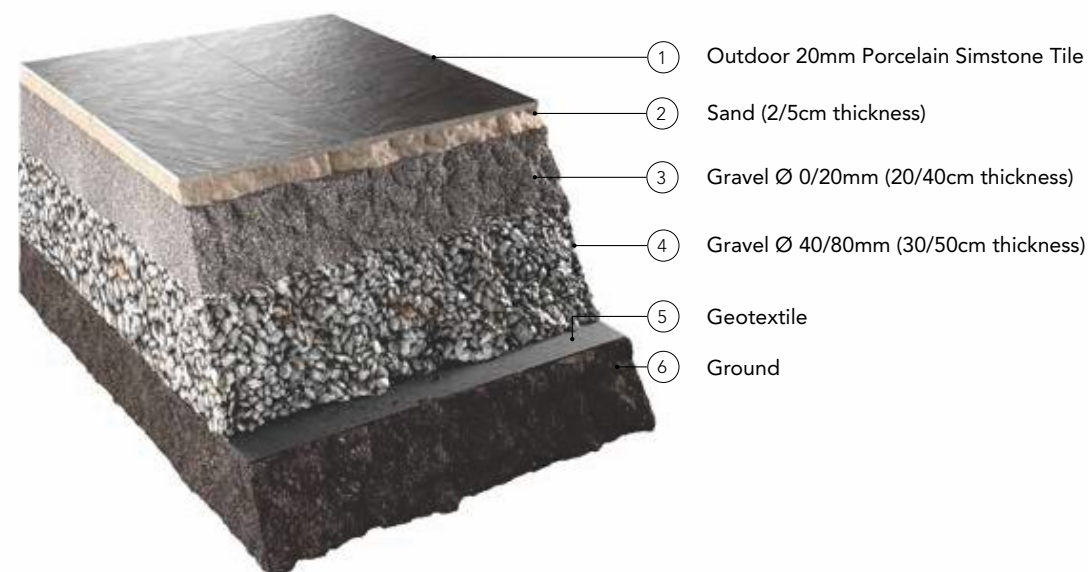
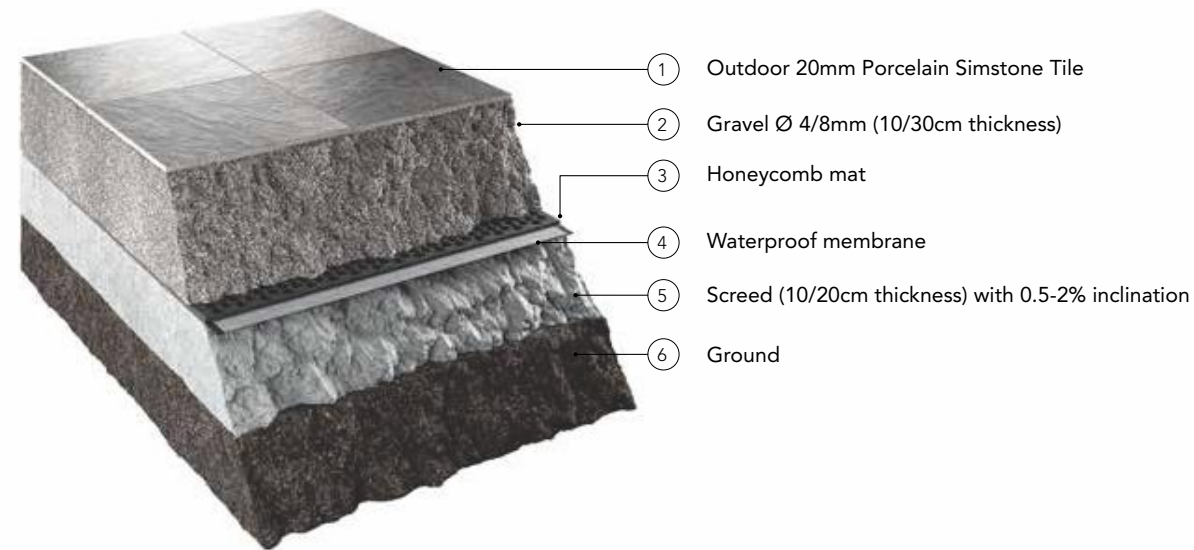

CAUTION

The application layers proposed are to be taken as an indication, and have the sole purpose of showing how to obtain a correct flooring. It is recommended to always refer to the specific norms and regulations in each individual country and the instructions of the project supervisor.

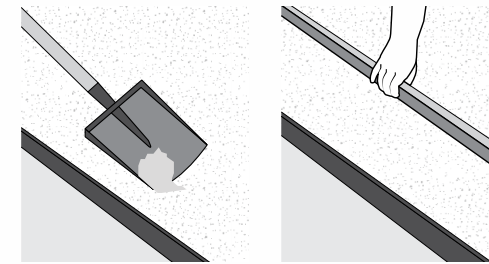

1/2

Form a stable and uniform substrate using fine gravel or sand. Level the substrate with a metal straight edge.

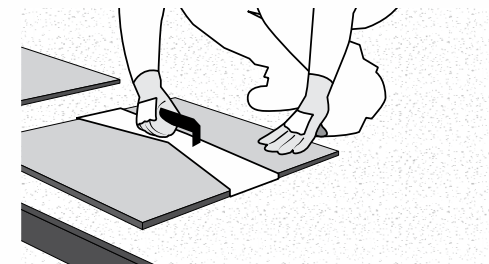

3

Position the tile and then compact the edges in order to level the tile with the substrate. It is suggested to use a joint of at least 4mm to allow good water drainage.



IN ORDER TO AVOID THE DISPLACEMENT OF THE SUBSTRATE AND CONSEQUENTLY THE TILES, THE SUBSTRATE MUST BE PARTITIONED WITH CONTAINMENT EDGES OR PERIMETER CURBS.

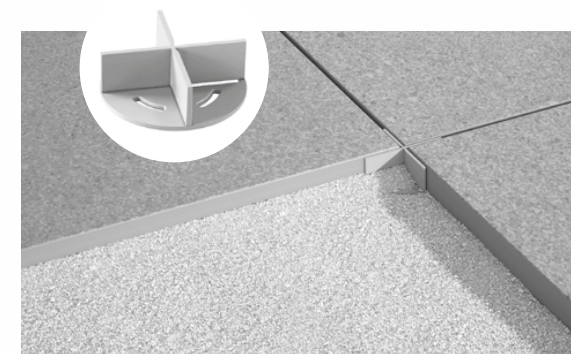

Spacers designed for laying tiles on sand or gravel are an extremely versatile and practical system despite their simplicity. The support is made up of a head with a spacer cross and a removable tip: the fins of the head cross help position the tiles and create the joint between them, ensuring that over time the flooring maintains its correct positioning. The tip is specific for application on sand: the elongated shape guarantees the anchorage and stability of the tiles, preventing them from slipping. For use on gravel, it is possible to remove the tip and place the spacer head directly on the gravel.

INSTALLATION ON SCREED WITH ADHESIVE

For installation on screed with adhesive we recommend a joint of at least 5mm. The size and position of the expansion joints must be established by the project supervisor; they must have an indicative width ranging from 4 to 12mm and divide the surface to be paved in a uniform

pattern with dimensions ranging from approximately 3x3m to 4x2.5m. To facilitate the flow of rainwater, it is always necessary to assess the slopes of outdoor paving; when laying with adhesives on screed, the slopes are determined by the latter.

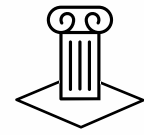

SAFE AND STABLE



LONG-LASTING

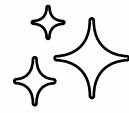

EASY TO CLEAN

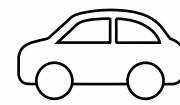

RESISTANT TO VEHICULAR
PASSAGE

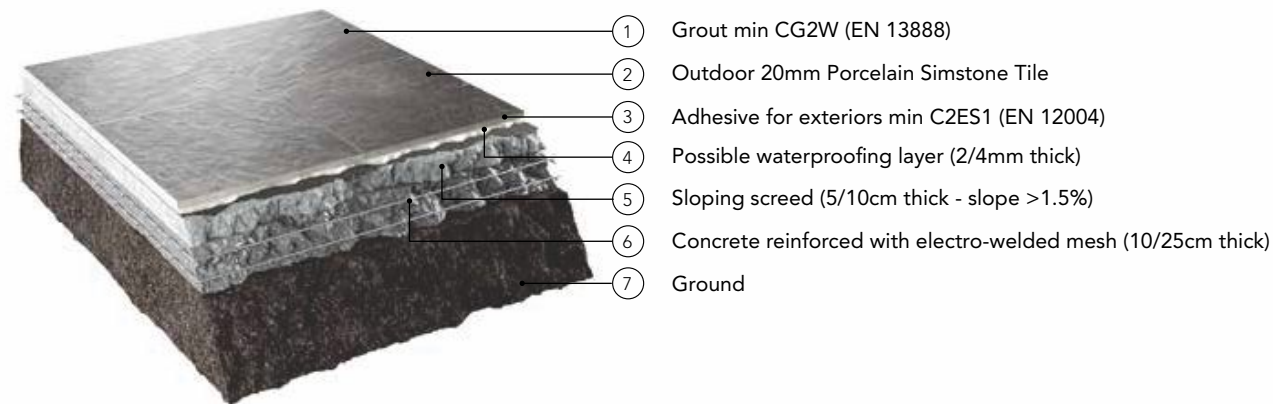

IN ORDER TO AVOID AESTHETICALLY UNPLEASANT CUTS OF THE TILES, IT IS SUGGESTED TO DEFINE THE SLOPES OF THE SCREED TAKING INTO ACCOUNT THE SIZE CHOSEN FOR THE INSTALLATION.

CAUTION

The application layers proposed are to be taken as an indication, and have the sole purpose of showing how to obtain a correct flooring. It is recommended to always refer to the specific norms and regulations in each individual country and the instructions of the Project Supervisor.

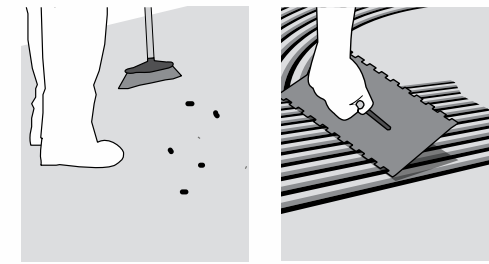

1/2

Before proceeding with the installation clean the substrate thoroughly. In order to obtain a flat floor, it is important to apply an even layer of adhesive.

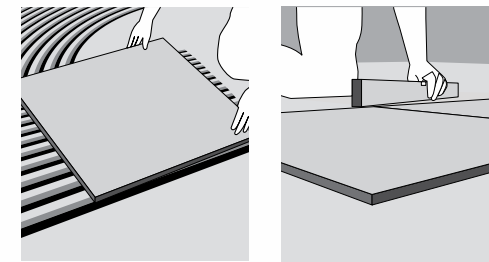

3/4

Check the planarity of the flooring regularly during the laying operations.

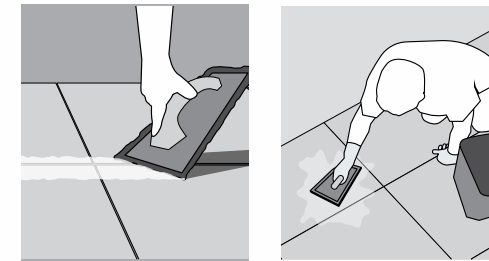

5/6

Once the installation is finished grout the flooring. Remember to observe the times indicated by the manufacturer for light foot traffic before walking on the tiles. "Post-installation" cleaning is mandatory at the end of the work and is required to remove residues of cement, lime or grout used for laying and filling the joints.

Expansion joints

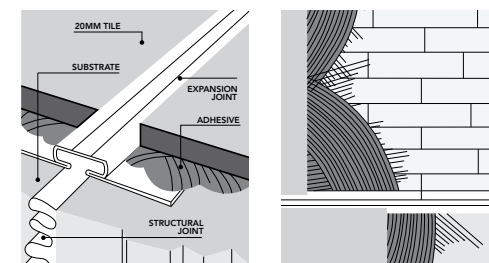

1/2

In correspondence with a structural or dividing joint in the screed, it is mandatory to provide an expansion joint with a width that is at least the size of the existing one. If there are joints between different surface types, it is mandatory to provide an expansion joint.

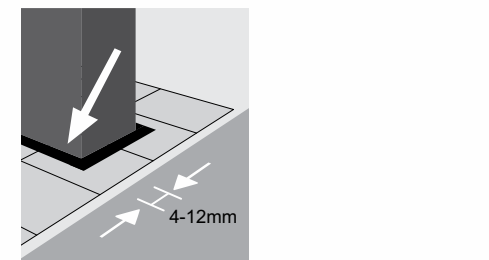

3

Around fixed elements of the supporting structure, such as walls, steps, columns, etc., it is mandatory to provide peripheral joints with a width of between 4 and 12mm.

ELEVATED FLOOR INSTALLATION

The elevated floor technology offers many specific and immediately perceivable advantages: it allows the passage of cables, pipes and necessary installations to be managed easily; it enables the underfloor to be inspected easily and guarantees an effective draining of rainwater. Thanks to the presence of

independent elements, elevated floors absorb expansion and structural movements, thus avoiding the formation of cracks on the waterproof embrane. The absence of the screed makes it possible to substantially reduce the weight that burdens the structures, while offering a high resistance to loads.

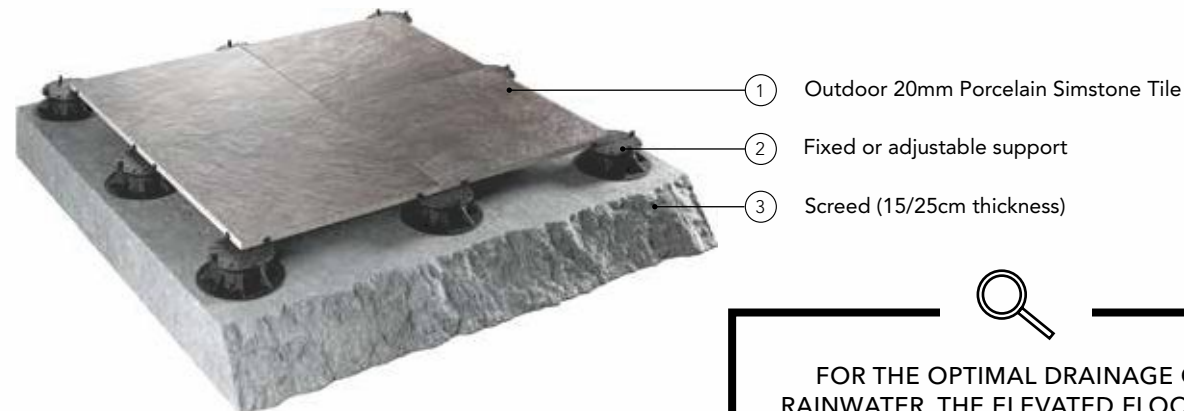

FOR THE OPTIMAL DRAINAGE OF RAINWATER, THE ELEVATED FLOORING MUST BE INSTALLED WITH A SLOPE OF BETWEEN 1.5% AND 2%.

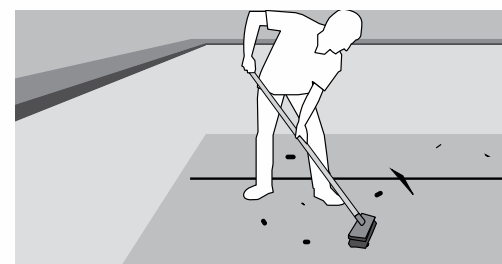

1 The installation on the plastic supports must only been done on perfectly waterproof substrates. Before proceeding with the installation clean the substrate thoroughly.

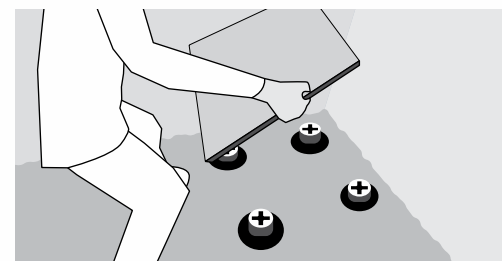

2 With regard to the number and position of the supports, as well as the type of reinforcement on the back of the slab, it is recommended to follow the instructions given in the following table, which are essential to evenly distribute the load.

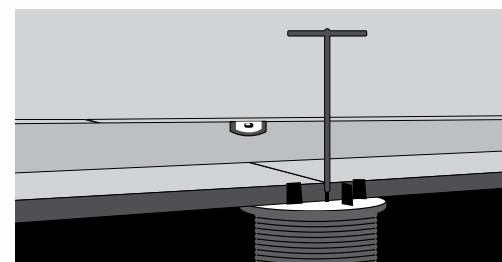

3 With the use of the special adjustment key it is possible to obtain a perfectly stable surface and with the required slope for better water drainage.

CAUTION

The application layers proposed are to be taken as an indication, and have the sole purpose of showing how to obtain a correct flooring. It is recommended to always refer to the specific norms and regulations in each individual country and the instructions of the project supervisor.

ELEVATED FLOOR INSTALLATION - SUPPORTS

Fixed supports and self-levelling adjustable supports

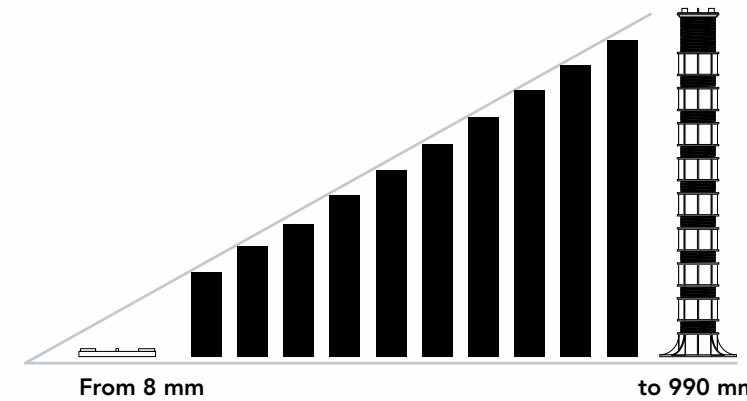

The structure of the supports consists of a base (which rests on the slab), a central screw adjustable in height and a head (on which the tile rests) which can be fixed or self-levelling with a self-adjustment system to alter inclination by up to 5°.

Technical characteristics of the supports

	They are made entirely of recycled and recyclable material
	Resistant to both acidic and alkaline solutions
	Resistant to atmospheric agents
	Resistant to temperatures of between -30 °C and +120°C
	Resistant to the crushing test with a load superior to 1 tonne
	Made of polypropylene
	Noise reduction of up to 25dB
	Possibility of using supports made with self-extinguishing material, which prevents the propagation of flames

Format	Elevated floor installation up to 2cm	Elevated floor installation 2-10cm	Elevated floor installation 10-30cm	Elevated floor installation 30-99cm
60x60cm	4 SUPPORTS 3+4 sup/m ²	4 SUPPORTS 3+4 sup/m ²	4 SUPPORTS + Reinforcement system or substructure of aluminium beams 3+4 sup/m ²	4 SUPPORTS + Reinforcement system or substructure of aluminium beams 3+4 sup/m ²
60x90cm	6 SUPPORTS 3+4 sup/m ²	6 SUPPORTS + Reinforcement system or substructure of aluminium beams 3+4 sup/m ²	6 SUPPORTS + Reinforcement system or substructure of aluminium beams 3+4 sup/m ²	6 SUPPORTS + Reinforcement system or substructure of aluminium beams 3+4 sup/m ²
60x120cm	6 SUPPORTS 3+4 sup/m ²	6 SUPPORTS + Reinforcement system or substructure of aluminium beams 3+4 sup/m ²	6 SUPPORTS + Reinforcement system or substructure of aluminium beams 3+4 sup/m ²	6 SUPPORTS + Reinforcement system or substructure of aluminium beams 3+4 sup/m ²

SPECIAL ELEMENTS

In order to guarantee excellent aesthetics and functionality for the various possible applications, the 20mm outdoor porcelain

Simstone tile collections have a rich set of step elements and special pieces.

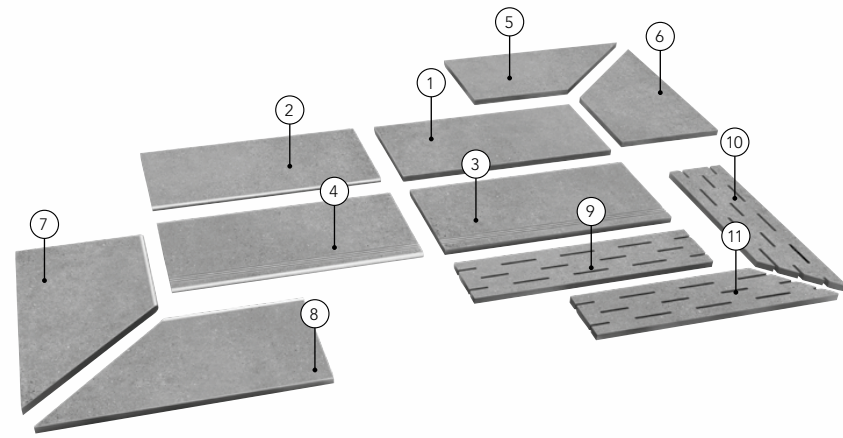

- ① Stair tile with straight edge
- ② Stair tile with rounded edge
- ③ Stair tile with straight ribbed edge
- ④ Stair tile with rounded ribbed edge
- ⑤ Right corner piece with straight edge
- ⑥ Left corner piece with straight edge
- ⑦ Left corner piece with rounded edge
- ⑧ Right corner piece with rounded edge
- ⑨ Grid
- ⑩ Right corner grid
- ⑪ Left corner grid

For the full range of special elements refer to the product catalogue.

STAIR TILE WITH STRAIGHT EDGE

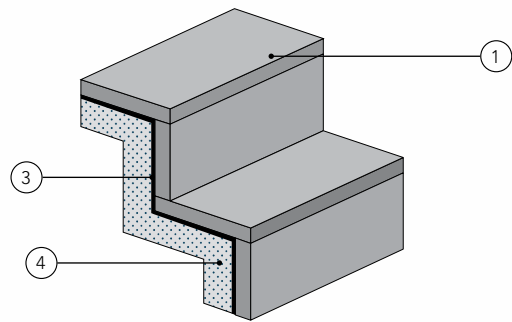

STAIR TILE WITH ROUNDED EDGE

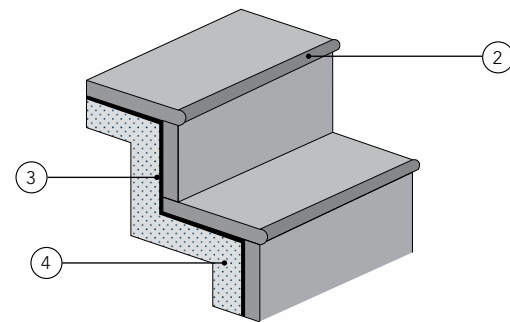

SWIMMING POOL EDGE

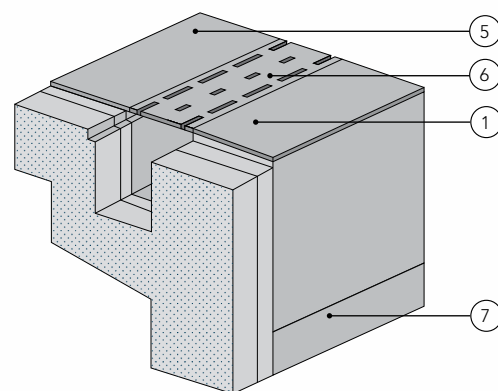

- ① Stair tile with straight edge
- ② Stair tile with rounded edge
- ③ Adhesive
- ④ Screed
- ⑤ Flooring
- ⑥ Grid
- ⑦ Swimming pool covering

CAUTION

The images are to be taken as an indication, and have the sole purpose of showing how to obtain a correct flooring. It is recommended to always refer to the specific norms and regulations in each individual country and the instructions of the project supervisor.

TECHNICAL SPECIFICATIONS

TEST DESCRIPTION	ISO-13006/EN176 GROUP BIA	MEAN VALUE OF SIMSTONE	TEST METHOD
Length & width	±0.6 %	±0.3mm	Passed
thickness 14mm	±5 %	±0.3mm	Passed
Straightness of side	±0.5 %	±0.3 %	Passed
Rectangularity	±0.6 %	±0.3 %	Passed
Surface flatness	±0.5 %	+0.35mm to -0.1mm	Passed
Surface quality	Minimum 95 %	Minimum 95 %	Passed
Water absorption	< 0.5 %	< 0.04 %	Passed
Breaking strength	> 1300N	> 1500N	Passed
Flexural strength (Average)	> 35N/mm ²	> 40N/mm ²	Passed
Scratch hardness of surface (Moh's scale)	> 6	> 6	Passed
Resistance to deep abrasion	<175mm ³	<144mm ³	Passed
Skid Resistance (Friction coefficient)	>0.4	>0.4	Passed
Bulk Density, in (g/cc)	>2	>2	Passed
Linear Thermal expansion	Max. 9.0 ⁴ x K ⁶ , Max	Max. 9.0 ⁶ x K ⁶ , Max	Passed
Thermal shock resistance	No damage	No damage	Passed
Frost resistance	Frost proof	Frost proof	Passed
Resistance to Chemical	Resistance	Resistance	Passed
Resistance to Stain	Resistant	Resistant	Passed
Moisture expansion	Nil	Nil	Passed
Colour resistance	Resistant	Resistant	Passed
Glossiness (Polished)	-	-	Passed

PACKING DETAILS

SIZE	WEIGHT/BOX (KG)	PIC/BOX	WEIGHT/PLT (KG)	BOXES/PLT	PLT/CTN	BOXES/CTN	MT ² /BOX	MT ² /PLT	MT ² /CTN	WIGHT/CTN
600x1200mm (20mm)	32.5	1	30	30	28	840	0.72	21.6	604.8	28000
600x900mm (20mm)	24.5	1	30	40	28	1120	0.54	21.6	604.8	28280
600x600mm (20mm)	32.75	2	30	32	26	832	0.72	23.04	599.04	28028
400x800mm (20mm)	-	-	-	-	-	-	-	-	-	-

PACKING DETAILS (PATIOPACK)

SIZE	PCS/CRAT	M2/PCS	SQFT/PCS	Mt2/CRATE	SQFT/CRATE	IN KGS/CRATE	CRATE/CTN	CRATE/CTN	IN KGS/PLT	IN KGS/CTN
600x900mm (20mm)	13	0.54	5.81	7.02	75.56	530.40	532.71	36	730	26280
600x600mm (20mm)	13	0.36	3.88	4.68	50.38	235.76				
296x600mm (20mm)	13	0.18	1.94	2.31	25.18	58.14				
296x296mm (20mm)	9	0.09	0.79	0.79	7.10	5.60				
	48			14.80	158.21	829.89	532.71	36.00	730.00	26280.00

www.simstoneceramic.in

SIMSTONE

SIMSTONE CERAMIC PVT. LTD.

Survey No. 132/P1 & P2, NH 8-A, Near Toll Plaza,
At. Vaghasiya, Wankaner - 363 622
Morbi, Gujarat, INDIA

export@simstone.in

Mo : 7567925522 / 9825830977